

! WARNING DO NOT CONNECT DIRECTLY TO AC/DC HIGH VOLTAGE POWER!
Read all warnings and installation instructions thoroughly.

SAFETY & WARNINGS

- Install in accordance with national and local electrical code regulations.
- This product is intended to be installed and serviced by a qualified, licensed electrician.
- This product must be powered with a compatible Class 2 DC Constant Voltage LED driver (power supply).
- DO NOT power strip light while attached to plastic spool or tightly coiled. Excess heat may melt the spool and/or cause damage to the fixture.
- DO NOT install in location where LED chips are exposed to direct sunlight or damage to the phosphor will occur.
- Ensure applicable wire is installed between driver, fixture, and any controls in between. When choosing wire, factor in voltage drop, amperage rating, and type (in-wall rated, wet location rated, etc.). Inadequate wire installation could overheat wires, and cause a fire.
- Strip light, attached wire leads, and additional extension cables, connectors, etc., are not rated for in-wall installation unless otherwise noted. Use wires rated for at least 176°F (80°C) and certified for use with external connection of electrical equipment.
- Connectors have a Class 2 amp limit unless otherwise noted.
- Each tape light has a different power consumption rating and maximum run length that must be individually wired to a compatible low voltage (PWM) control or LED driver. Refer to tape light package label or spec sheet for more information.
- Tape light must be handled with care. Excessive handling, bending, and pressure may damage the product, voiding the warranty.



QUICK SPECS

Input Voltage	24V DC	Included Model(s)	24V
MODEL	FINE 84	Ambient Temperature †	-4° ~ 122°F (-20° ~ 50°C)
Maximum Run	5/25 m	Environment	Dry location

† Do not install product in an environment outside the listed ambient temperature. Ensure adequate airflow and heatsinking is considered when mounting/installing.

! Operation Attention:

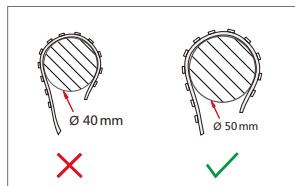

Do not bend LED Strip light to a diameter less than 40mm(1.5 inches)

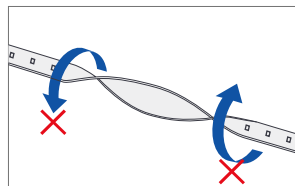

Do not bend LED Strip light like this, and this way will break the LED and bonding pad

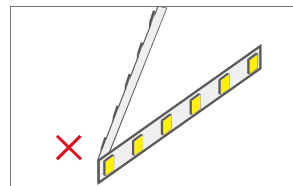

Do not fold or crease LED Strip light, and this way will break the LED and bonding pad

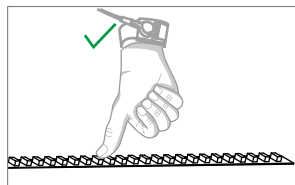

Touching LED, pls wear the electrostatic ring for avoiding ESD

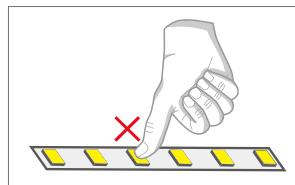

Do not put press heavily or put excessive pressure on surface of LED

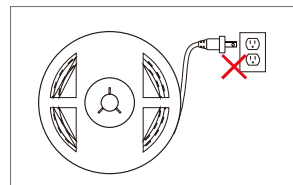

Do not connect directly LED Strip light to AC /DC high voltage power!

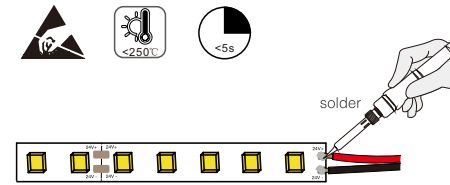
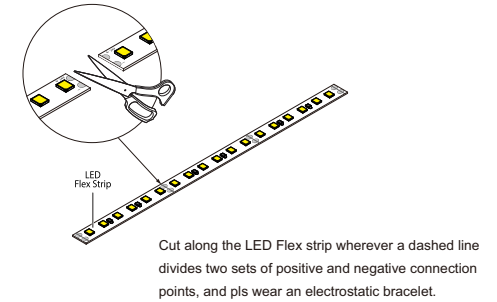
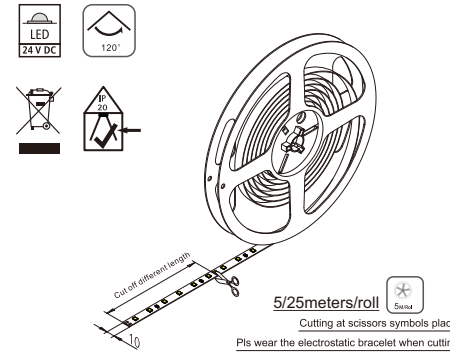

Connecting two welded parts with a maximum temperature of 250 ° C and no more than 5 seconds, and you must wear an electrostatic bracelet.

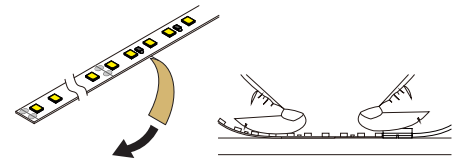

Attach the strip to the installation position, and Adhere to a smooth, dry surface, working one end to the other.

single color

