

***DISCOVERY***

**CHW54**

**Tough Motion Sensor Work Headlamp**

**Quick Start Guide**

**GP**

Motion Sensor  
LED Indicator

A B

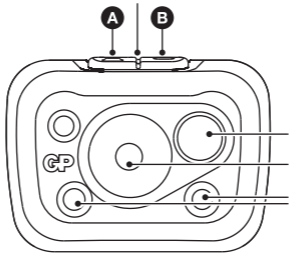

Flood Light

Spot Light

IR Sensor

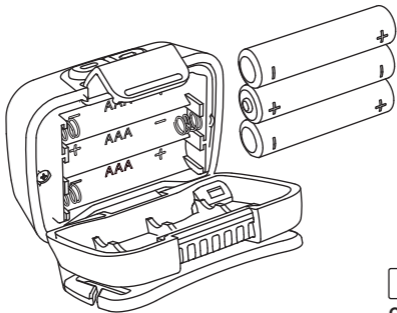

Compatible

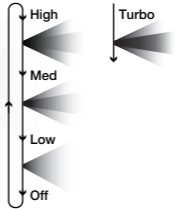
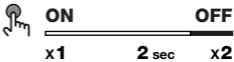
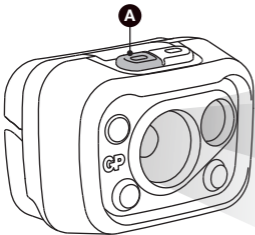

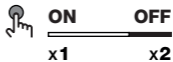
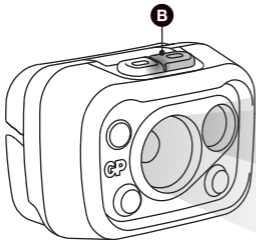

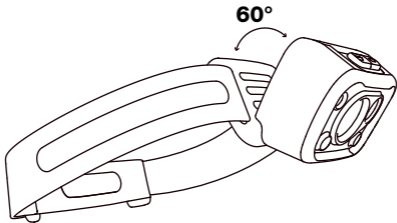

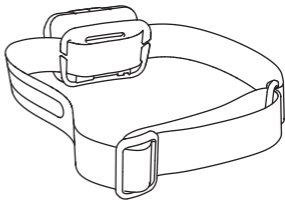
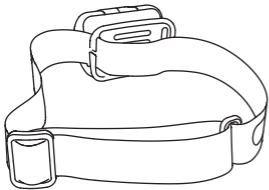



gpbatteries.com

ANSI FL1 Standard	Turbo	High	Med	Low
-------------------	-------	------	-----	-----



375	200	55	34
-----	-----	----	----



110	80	50	10
-----	----	----	----



4	9	17	26
---	---	----	----



IPX5



5m

CAUTION!

