



50W Constant Power Mode LED Driver

**XLG-50** series



IS 15885 (Part 2/Sec13)  
R-41027766  
(for XLG-50I type only)



Note.15



## Features

- Constant Power mode output
- Metal housing design with functional Ground
- Built-in active PFC function
- Class 2 power unit
- No load / Standby power consumption <0.5W
- IP67 rating for indoor or outdoor installations
- Function options: output adjustable via potentiometer  
3 in 1 dimming function (Dim to off and Isolation design)
- Typical lifetime>50000 hours
- 5 years warranty

## Applications

- LED street lighting
- LED architectural lighting
- LED bay lighting
- LED floodlighting
- Type "HL" for use in Class I, Division 2 hazardous (Classified) location.

## Description

XLG-50 series is a 50W AC/DC LED driver featuring the constant power mode output. XLG-50 operates from 90~305VAC. Thanks to the high efficiency up to 90%, The entire series is able to operate between -40°C~90°C wide case temperature range with air convection. The design of metal housing and IP67 ingress protection level allows this series to fit both indoor and outdoor applications. XLG-50 is equipped with various function options, such as dimming methodologies, so as to provide the optimal design flexibility for LED lighting system. XLG-50 series comply with the latest version of IEC61347/GB7000.1-2015 and UL8750 international safety regulations. The output and dimming circuit are also completely in accordance with the new regulations with isolation to ensure the safety of both user and luminaire system during installation.

## Model Encoding

**XLG - 50 I - A**

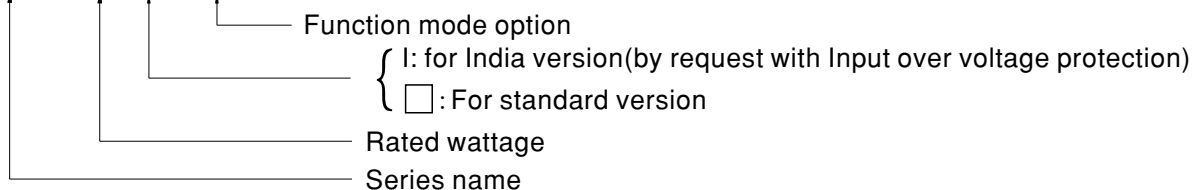

Type	IP Level	Function	Note
A	IP67	Io adjustable through built in potentiometer.	In Stock
AB	IP67	Io adjustable through built in potentiometer 3 in 1 dimming function (0~10Vdc, 10V PWM signal and resistance)	In Stock



## 50W Constant Power Mode LED Driver

## XLG-50 series

## SPECIFICATION

MODEL		XLG-50 □ - □			
OUTPUT	RATED CURRENT	1A			
	CONSTANT CURRENT REGION Note.2	22 ~ 54V			
	RATED POWER Note.5	100VAC ~ 305VAC 50W			
	CURRENT RIPPLE	5.0% max. @rated current			
	OPEN CIRCUIT VOLTAGE (max.)	57V			
	CURRENT ADJ. RANGE	0.53 ~ 2.1A			
	SETUP, RISE TIME Note.3	500ms, 100ms/115VAC, 230VAC			
INPUT	VOLTAGE RANGE Note.4	90 ~ 305VAC 142 ~ 431VDC (Please refer to "STATIC CHARACTERISTIC" section)			
	FREQUENCY RANGE	47 ~ 63Hz			
	POWER FACTOR	PF ≥ 0.97/115VAC, PF ≥ 0.95/230VAC, PF ≥ 0.92/277VAC@full load (Please refer to "POWER FACTOR (PF) CHARACTERISTIC" section)			
	TOTAL HARMONIC DISTORTION	THD < 10% (@load ≥ 50%/115VAC, 230VAC; @load ≥ 75%/277VAC) (Please refer to "TOTAL HARMONIC DISTORTION (THD)" section)			
	EFFICIENCY (Typ.) Note.10	90%			
	AC CURRENT	0.57A / 115VAC 0.29A / 230VAC 0.24A/277VAC			
	INRUSH CURRENT(Typ.)	COLD START 50A(twidth=350µs measured at 50% Ipeak) at 230VAC; Per NEMA 410			
	MAX. No. of PSUs on 16A CIRCUIT BREAKER	5 units (circuit breaker of type B) / 8 units (circuit breaker of type C) at 230VAC			
	LEAKAGE CURRENT	<0.75mA / 277VAC			
	NO LOAD / STANDBY POWER CONSUMPTION	No load power consumption <0.5W for A, <0.75W for I series Standby power consumption <0.5W for AB			
PROTECTION	OVER POWER	110-150% Over Power Protection, recovers automatically after fault condition is removed			
	SHORT CIRCUIT	Constant current limiting, recovers automatically after fault condition is removed			
	OVER TEMPERATURE	Hiccup mode, recovers automatically after fault condition is removed			
	INPUT OVER VOLTAGE Note.8	320 ~ 370VAC (Shut down output voltage when the input voltage exceeds protection voltage, recovers automatically after fault condition is removed) Can survive input voltage stress of 440Vac for 48 hours @ tc 75°C max			
ENVIRONMENT	WORKING TEMP.	Tcase=-40 ~ +90°C (Please refer to " OUTPUT LOAD vs TEMPERATURE" section)			
	MAX. CASE TEMP.	Tcase=+90°C			
	WORKING HUMIDITY	20 ~ 95%			
	STORAGE TEMP.	-40 ~ +80°C			
	TEMP. COEFFICIENT	±0.03%/°C (0 ~ 60°C)			
VIBRATION	10 ~ 500Hz, 5G 12min./1cycle, period for 72min. each along X, Y, Z axes				
SAFETY & EMC	SAFETY STANDARDS Note.8	UL8750(type"HL"), CSA C22.2 No. 250.13-12; ENEC AS/NZS IEC EN61347-1, AS/NZS EN61347-2-13 independent, EN62384; IP67; GB19510.1, GB19510.14, EAC TP TC 004, J61347-1(H29), J61347-2-13(H29), KC61347-1, KC61347-2-13, IS15885(Part2/Sec13)( for XLG-50I type only); NOM-058-SCFI-2017 approved			
	WITHSTAND VOLTAGE	I/P-O/P:3.75KVAC I/P-FG:2.0KVAC O/P-FG:1.5KVAC			
	ISOLATION RESISTANCE	I/P-O/P, I/P-FG, O/P-FG:100M Ohms / 500VDC / 25°C / 70% RH			
EMC EMISSION	EMC EMISSION	Parameter	Standard	Test Level/Note	
		Conducted	EN55015(CISPR15) ,GB/T17743	-----	
		Radiated	EN55015(CISPR15) ,GB/T17743	-----	
		Harmonic Current	EN61000-3-2 ,GB/T17625.1	Class C @load ≥ 50%	
		Voltage Flicker	EN61000-3-3	-----	
	EMC IMMUNITY	EMC IMMUNITY	Parameter	Standard	Test Level/Note
			ESD	EN61000-4-2	Level 3, 8KV air ; Level 2, 4KV contact
			Radiated	EN61000-4-3	Level 3
			EFT/Burst	EN61000-4-4	Level 3
			Surge	EN61000-4-5	4KV/Line-Line 6KV/Line-Earth
OTHERS	OTHERS	Conducted	EN61000-4-6	Level 3	
		Magnetic Field	EN61000-4-8	Level 4	
		Voltage Dips and Interruptions	EN61000-4-11	>95% dip 0.5 periods, 30% dip 25 periods, >95% interruptions 250 periods	
		MTBF	1252.69 K hrs min. Telcordia SR-332 (Bellcore) 394.57Khrs min. MIL-HDBK-217F (25°C)		
		DIMENSION	105*63*30mm (L*W*H)		
PACKING	0.41Kg;24pcs/ 10.5Kg/0.68CUFT for A-type 0.42Kg;24pcs/ 11Kg/0.68CUFT for AB-type				
NOTE	NOTE				
	1. All parameters NOT specially mentioned are measured at 230VAC input, rated current and 25°C of ambient temperature.				
	2. Please refer to "DRIVING METHODS OF LED MODULE".				
	3. Length of set up time is measured at first cold start. Turning ON/OFF the driver may lead to increase of the set up time.				
	4. De-rating may be needed under low input voltages. Please refer to "STATIC CHARACTERISTIC" sections for details.				
	5. The driver is considered as a component that will be operated in combination with final equipment. Since EMC performance will be affected by the complete installation, the final equipment manufacturers must re-qualify EMC Directive on the complete installation again.				
	6. This series meets the typical life expectancy of >50,000 hours of operation when Tcase, particularly (C) point (or TMP, per DLC), is about 75°C or less.				
	7. Please refer to the warranty statement on MEAN WELL's website at <a href="http://www.meanwell.com">http://www.meanwell.com</a>				
	8. Input over voltage only for XLG-50 I series, and I series without UL/CSA certificate.				
	9. The ambient temperature derating of 3.5°C/1000m with fanless models and of 5°C/1000m with fan models for operating altitude higher than 2000m(6500ft).				
	10. Only for XLG-50-A				
	11. Products sourced from the Americas regions may not have the CCC/PSE/BIS/KC logo. Please contact your MEAN WELL sales for more information.				
	12. For any application note and IP water proof function installation caution, please refer our user manual before using. <a href="https://www.meanwell.com/Upload/PDF/LED_EN.pdf">https://www.meanwell.com/Upload/PDF/LED_EN.pdf</a>				
	13. Ripple & noise are measured at 20MHz of bandwidth by using a 12" twisted pair-wire terminated with a 0.1µf & 47µf parallel capacitor.				
	14. To fulfill requirements of the latest ErP regulation for lighting fixture, this LED driver can only be used behind a switch without permanently connected to the mains.				
15. If you need the NOM (Mexico) certificate, Please contact MEAN WELL sales representative for details.					



50W Constant Power Mode LED Driver

**XLG-50 series**

■ **Block Diagram**

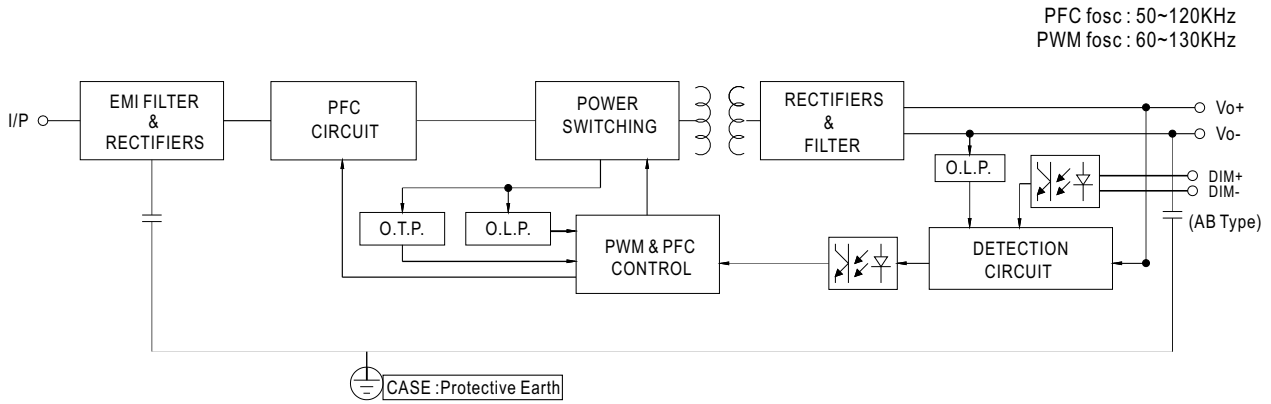

■ **DRIVING METHODS OF LED MODULE**

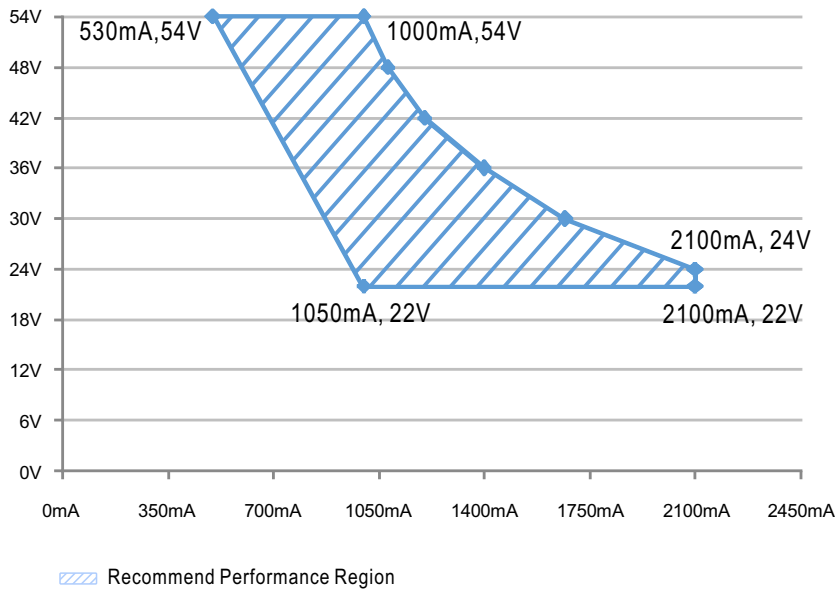



**■ DIMMING OPERATION**

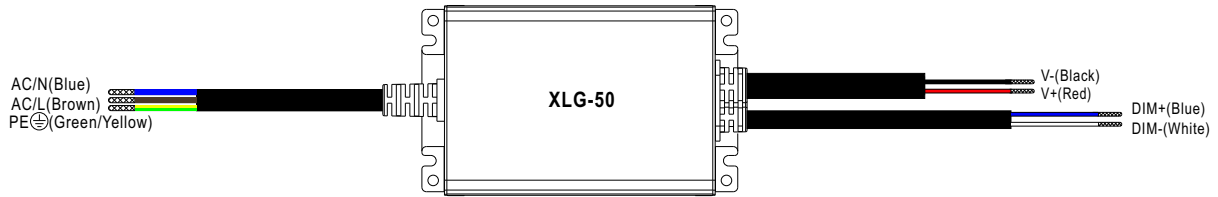

※ **3 in 1 dimming function (for AB-Type)**

- Output constant current level can be adjusted by applying one of the three methodologies between DIM+ and DIM-:  
0 ~ 10VDC, or 10V PWM signal or resistance.
- Direct connecting to LEDs is suggested. It is not suitable to be used with additional drivers.
- Dimming source current from power supply: 100 $\mu$ A (typ.)

◎ Applying additive 0 ~ 10VDC

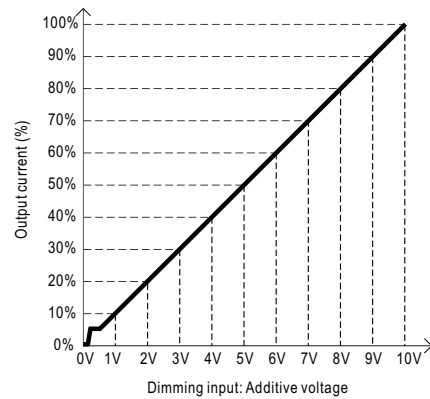
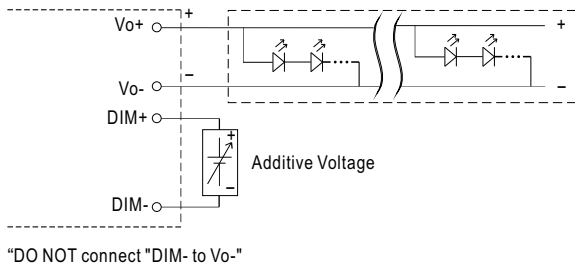

◎ Applying additive 10V PWM signal (frequency range 100Hz ~ 3KHz):

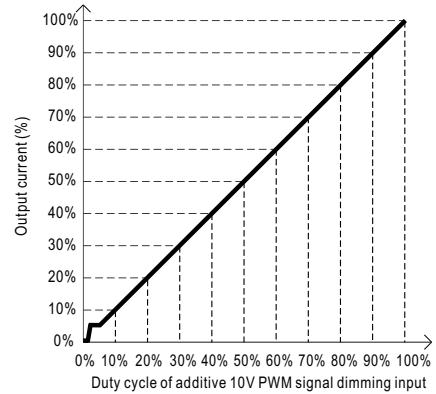
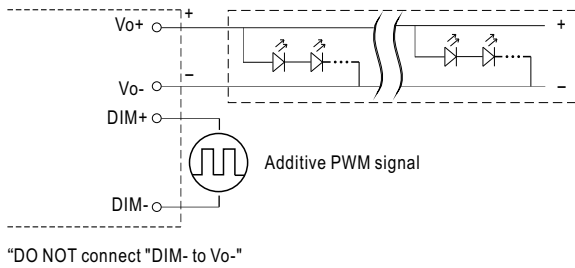

◎ Applying additive resistance:

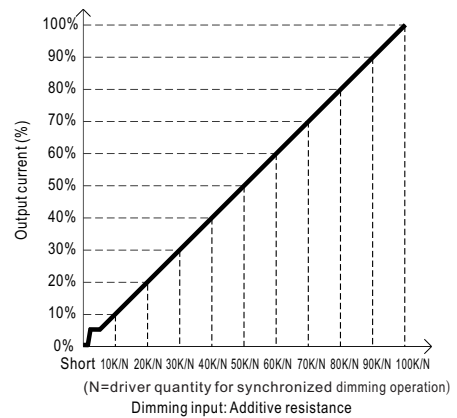
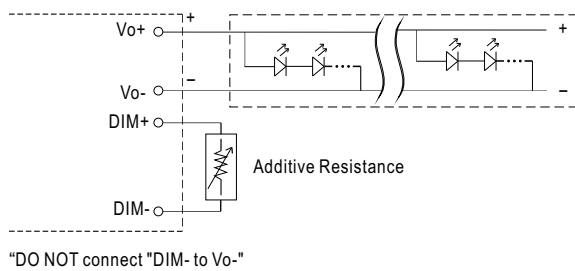

Note : 1. Min. dimming level is about 8% and the output current is not defined when 0% < Iout < 8%.  
2. The output current could drop down to 0% when dimming input is about 0k $\Omega$  or 0Vdc, or 10V PWM signal with 0% duty cycle.



**OUTPUT LOAD vs TEMPERATURE**

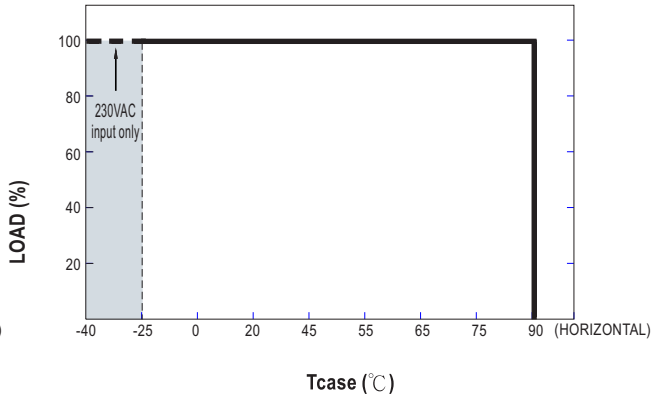
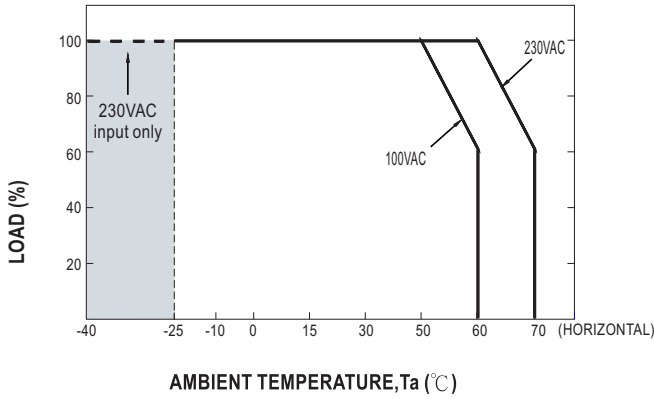

**STATIC CHARACTERISTIC**

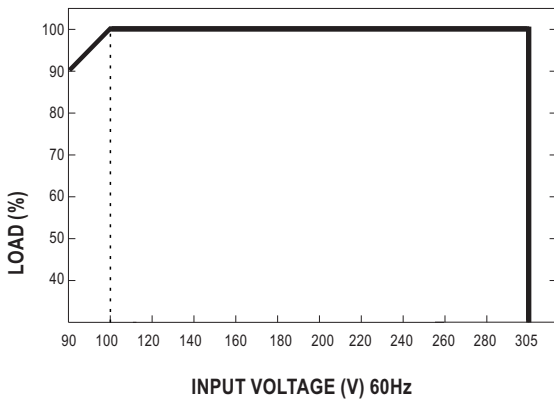

※ De-rating is needed under low input voltage.

**POWER FACTOR (PF) CHARACTERISTIC**

※ Tcase at 75°C

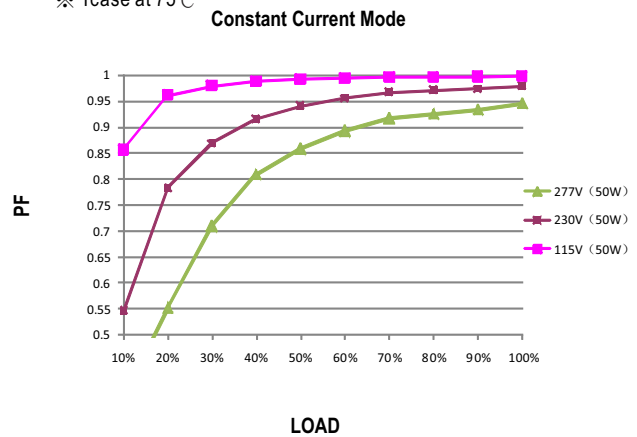

**TOTAL HARMONIC DISTORTION (THD)**

※ 50V Model, Tcase at 75°C

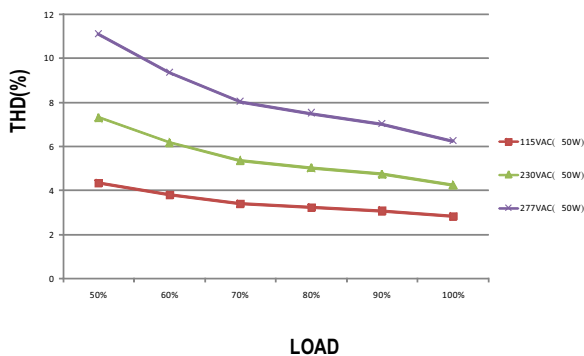

**EFFICIENCY vs LOAD**

XLG-50 series possess superior working efficiency that up to 90% can be reached in field applications.

※ 50V Model, Tcase at 75°C

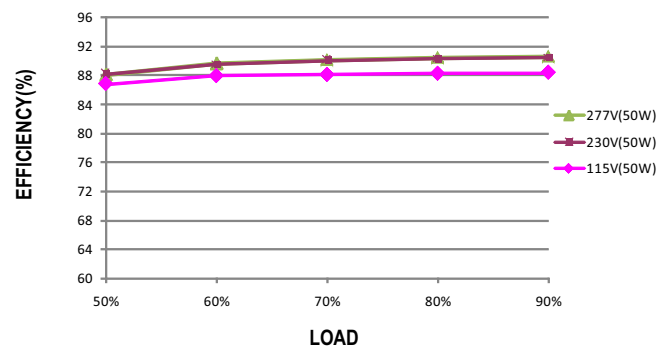



50W Constant Power Mode LED Driver

**XLG-50** series

■ LIFE TIME

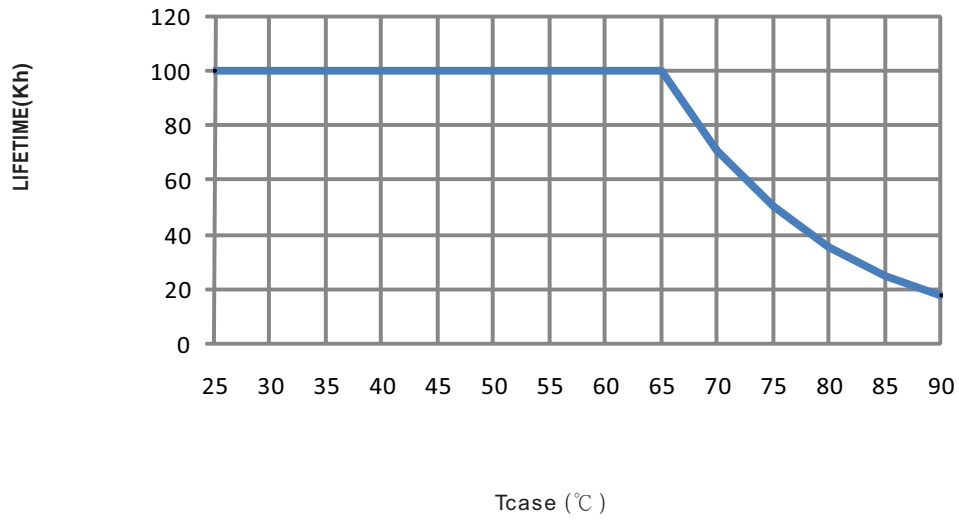



50W Constant Power Mode LED Driver

**XLG-50** series

■ Mechanical Specification

※ A-Type

CASE NO.: 268A

Unit:mm

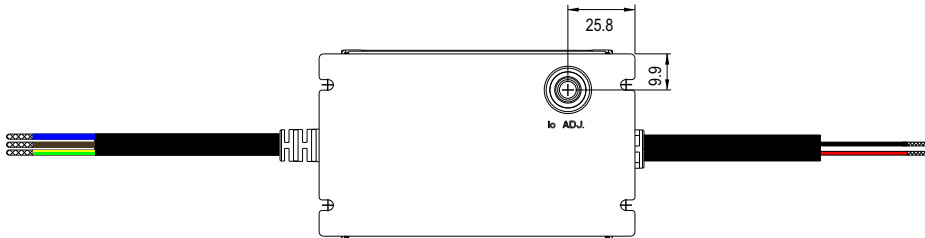
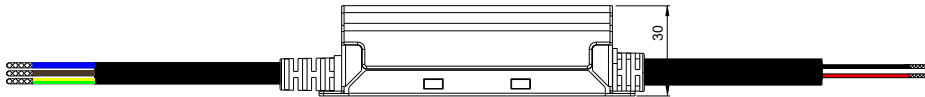
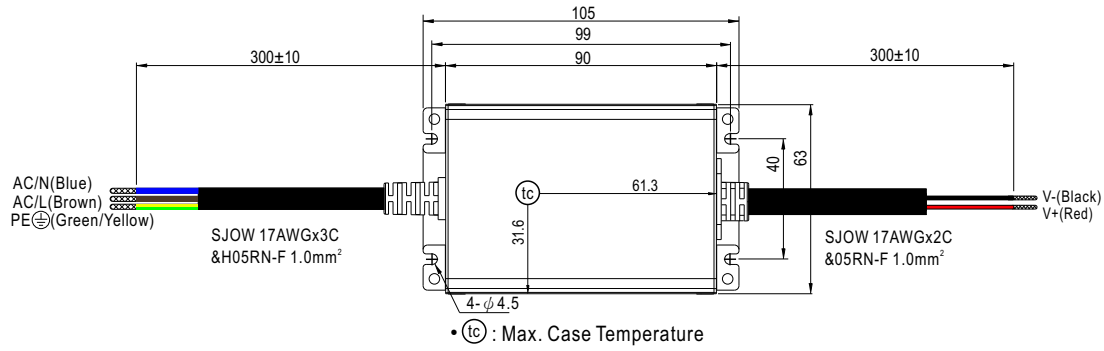



# 50W Constant Power Mode LED Driver

# XLG-50 series

## ※ AB-Type

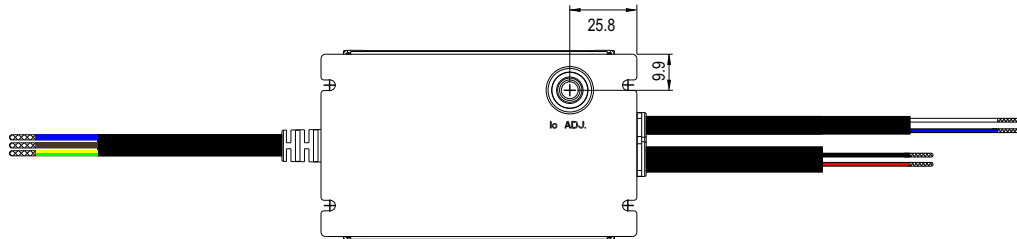
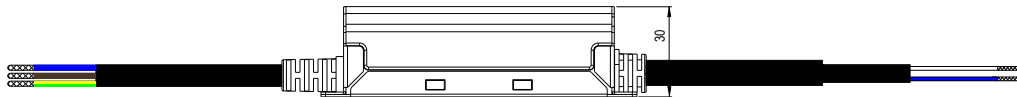
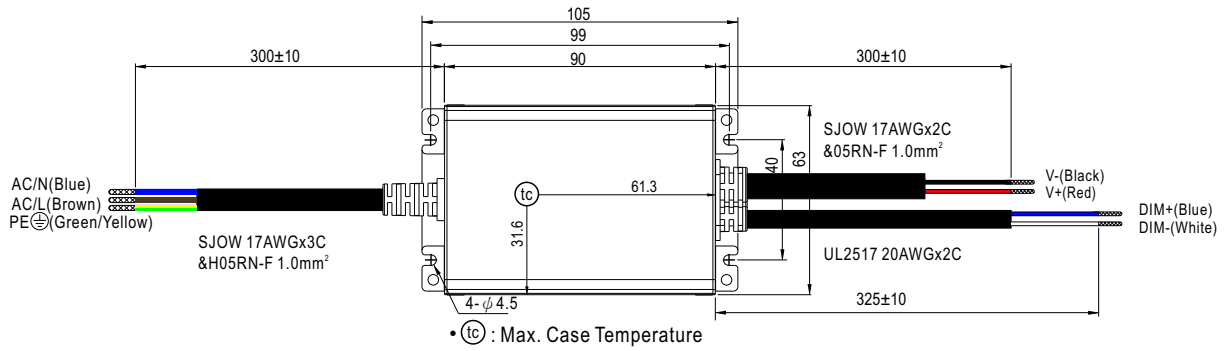

## ■ Installation Manual

Please refer to : <http://www.meanwell.com/manual.html>