

FEATURES

- Low Power: $I_{CC} = 300\mu\text{A}$ Typical
- Designed for RS485 or RS422 Applications
- Single 5V Supply
- -7V to 12V Bus Common-Mode Range
Permits $\pm 7\text{V}$ Ground Difference Between Devices on the Bus
- Thermal Shutdown Protection
- Power-Up/Down Glitch-Free Driver Outputs Permit Live Insertion or Removal of Package
- Driver Maintains High Impedance with the Power Off
- Combined Impedance of a Driver Output and Receiver Allows up to 32 Transceivers on the Bus
- 70mV Typical Input Hysteresis
- 28ns Typical Driver Propagation Delays with 5ns Skew
- Pin Compatible with the SN75179

DESCRIPTION

The LTC490 is a low power differential bus/line transceiver designed for multipoint data transmission standard RS485 applications with extended common-mode range (12V to -7V). It also meets the requirements of RS422.

The CMOS design offers significant power savings over its bipolar counterpart without sacrificing ruggedness against overload or ESD damage.

Excessive power dissipation caused by bus contention or faults is prevented by a thermal shutdown circuit which forces the driver outputs into a high impedance state. The receiver has a fail safe feature which guarantees a high output state when the inputs are left open.

Both AC and DC specifications are guaranteed from 0°C to 70°C and 4.75V to 5.25V supply voltage range.

APPLICATIONS

- Low Power RS485/RS422 Transceiver
- Level Translator

TYPICAL APPLICATION

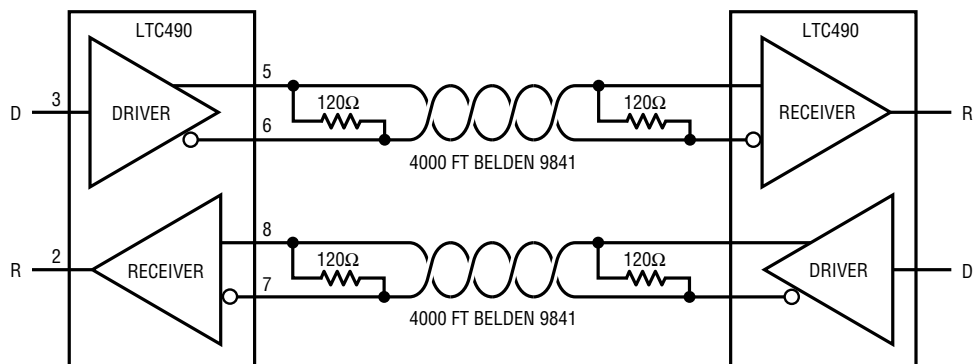

LTC490 • TA01

ABSOLUTE MAXIMUM RATINGS

(Note 1)

Supply Voltage (V _{CC})	12V
Driver Input Currents	-25mA to 25mA
Driver Input Voltages	-0.5V to V _{CC} +0.5V
Driver Output Voltages	±14V
Receiver Input Voltages	±14V
Receiver Output Voltages	-0.5V to V _{CC} +0.5V
Operating Temperature Range	
LTC490C	0°C to 70°C
LTC490I	-40°C to 85°C
Storage Temperature Range	-65°C to 150°C
Lead Temperature (Soldering, 10 sec)	300°C

PACKAGE/ORDER INFORMATION

<p>TOP VIEW</p> <p>N8 PACKAGE 8-LEAD PLASTIC DIP</p> <p>S8 PACKAGE 8-LEAD PLASTIC SOIC</p> <p>T_{JMAX} = 125°C, θ_{JA} = 100°C/W (N8) T_{JMAX} = 150°C, θ_{JA} = 150°C/W (S8)</p>	ORDER PART NUMBER
	LTC490CN8 LTC490CS8 LTC490IN8 LTC490IS8
	S8 PART MARKING
	490 490I

Consult factory for Military grade parts.

DC ELECTRICAL CHARACTERISTICS

V_{CC} = 5V ±5%

SYMBOL	PARAMETER	CONDITIONS	MIN	TYP	MAX	UNITS
V _{OD1}	Differential Driver Output Voltage (Unloaded)	I _O = 0			5	V
V _{OD2}	Differential Driver Output Voltage (with Load)	R = 50Ω (RS422)		2		V
		R = 27Ω (RS485) (Figure 1)		1.5	5	V
ΔV _{OD}	Change in Magnitude of Driver Differential Output Voltage for Complementary Output States	R = 27Ω or R = 50Ω (Figure 1)			0.2	V
V _{OC}	Driver Common-Mode Output Voltage	R = 27Ω or R = 50Ω (Figure 1)			3	V
Δ V _{OC}	Change in Magnitude of Driver Common Mode Output Voltage for Complementary Output States	R = 27Ω or R = 50Ω (Figure 1)			0.2	V
V _{IH}	Input High Voltage (D)		2.0			V
V _{IL}	Input Low Voltage (D)				0.8	V
I _{IN1}	Input Current (D)				±2	μA
I _{IN2}	Input Current (A, B)	V _{CC} = 0V or 5.25V	V _{IN} = 12V		1	mA
			V _{IN} = -7V		-0.8	mA
V _{TH}	Differential Input Threshold Voltage for Receiver	-7V ≤ V _{CM} ≤ 12V	-0.2		0.2	V
ΔV _{TH}	Receiver Input Hysteresis	V _{CM} = 0V		70		mV
V _{OH}	Receiver Output High Voltage	I _O = -4mA, V _{ID} = 0.2V	3.5			V
V _{OL}	Receiver Output Low Voltage	I _O = 4mA, V _{ID} = -0.2V			0.4	V
I _{OZR}	Three-State Output Current at Receiver	V _{CC} = Max 0.4V ≤ V _O ≤ 2.4V			±1	μA
I _{CC}	Supply Current	No Load; D = GND or V _{CC}		300	500	μA
R _{IN}	Receiver Input Resistance	-7V ≤ V _O ≤ 12V	12			kΩ
I _{OSD1}	Driver Short-Circuit Current, V _{OUT} = High	V _O = -7V		100	250	mA
I _{OSD2}	Driver Short-Circuit Current, V _{OUT} = Low	V _O = 12V		100	250	mA
I _{OSR}	Receiver Short-Circuit Current	0V ≤ V _O ≤ V _{CC}	7		85	mA
I _{OZ}	Driver Three-State Output Current	V _O = -7V to 12V		±2	±200	μA

SWITCHING CHARACTERISTICS

$V_{CC} = 5V \pm 5\%$

SYMBOL	PARAMETER	CONDITIONS		MIN	TYP	MAX	UNITS
t_{PLH}	Driver Input to Output	$R_{DIFF} = 54\Omega, C_{L1} = C_{L2} = 100pF$ (Figures 2, 3)	●	10	30	50	ns
t_{PHL}	Driver Input to Output	$R_{DIFF} = 54\Omega, C_{L1} = C_{L2} = 100pF$ (Figures 2, 3)	●	10	30	50	ns
t_{SKEW}	Driver Output to Output	$R_{DIFF} = 54\Omega, C_{L1} = C_{L2} = 100pF$ (Figures 2, 3)	●		5		ns
t_r, t_f	Driver Rise or Fall Time	$R_{DIFF} = 54\Omega, C_{L1} = C_{L2} = 100pF$ (Figures 2, 3)	●	5	5	25	ns
t_{PLH}	Receiver Input to Output	$R_{DIFF} = 54\Omega, C_{L1} = C_{L2} = 100pF$ (Figures 2, 4)	●	40	70	150	ns
t_{PHL}	Receiver Input to Output	$R_{DIFF} = 54\Omega, C_{L1} = C_{L2} = 100pF$ (Figures 2, 4)	●	40	70	150	ns
t_{SKD}	$ t_{PLH} - t_{PHL} $ Differential Receiver Skew	$R_{DIFF} = 54\Omega, C_{L1} = C_{L2} = 100pF$ (Figures 2, 4)	●		13		ns

The ● denotes specifications which apply over the full operating temperature range.

Note 1: Absolute maximum ratings are those beyond which the safety of the device cannot be guaranteed.

Note 2: All currents into device pins are positive; all currents out of device pins are negative. All voltages are referenced to device ground unless otherwise specified.

Note 3: All typicals are given for $V_{CC} = 5V$ and Temperature = 25°C.

TYPICAL PERFORMANCE CHARACTERISTICS

Driver Output High Voltage vs Output Current

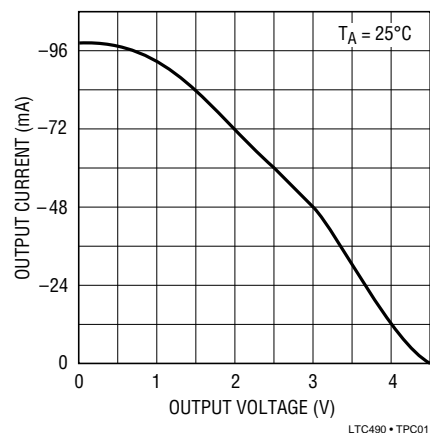

Driver Differential Output Voltage vs Output Current

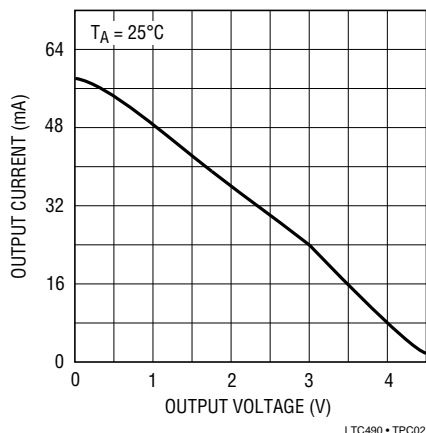

Driver Output Low Voltage vs Output Current

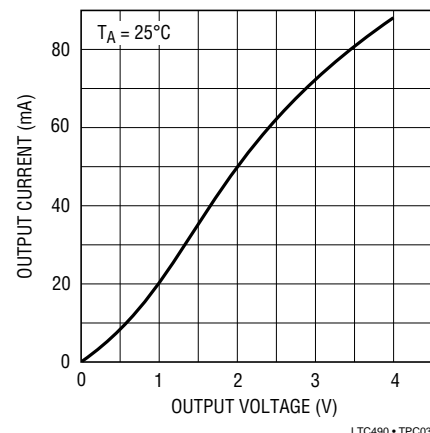

TTL Input Threshold vs Temperature

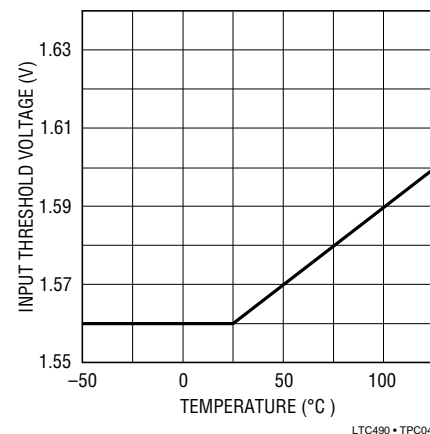

Driver Skew vs Temperature

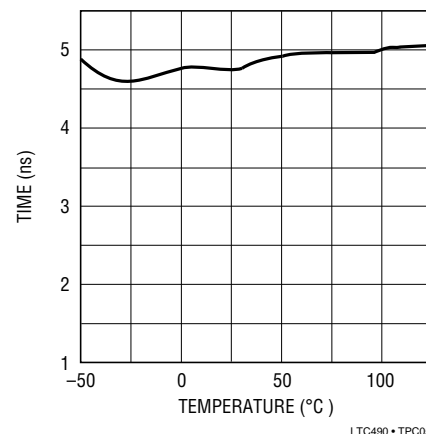

Supply Current vs Temperature

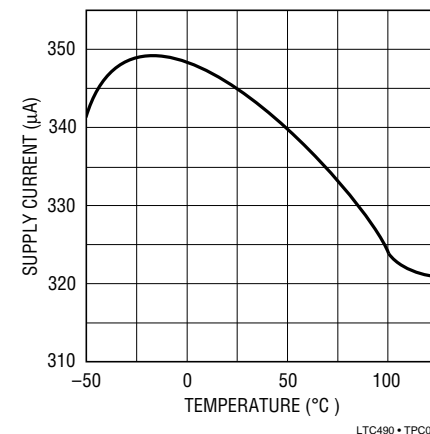

TYPICAL PERFORMANCE CHARACTERISTICS

Driver Differential Output Voltage vs Temperature

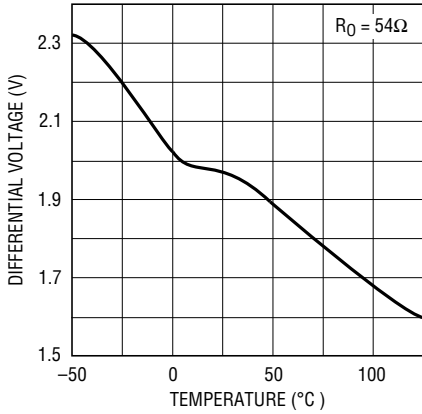

LTC490 • TPC07

Receiver |t_{PLH}-t_{PHL}| vs Temperature

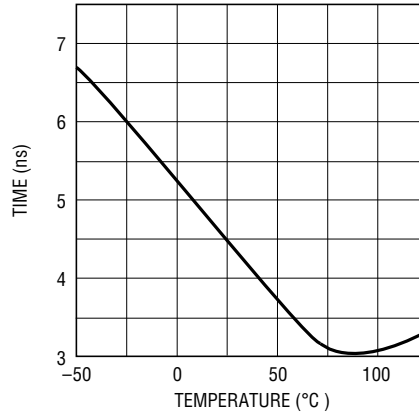

LTC490 • TPC08

Receiver Output Low Voltage vs Temperature

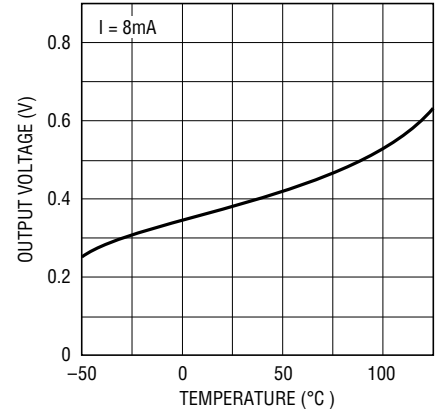

LTC490 • TPC09

PIN FUNCTIONS

V_{CC} (Pin 1): Positive Supply; $4.75V \leq V_{CC} \leq 5.25V$.

R (Pin 2): Receiver Output. If $A > B$ by 200mV, R will be high. If $A < B$ by 200mV, then R will be low.

D (Pin 3): Driver Input. A low on D forces the driver outputs A low and B high. A high on D will force A high and B low.

GND (Pin 4): Ground Connection.

Y (Pin 5): Driver Output.

Z (Pin 6): Driver Output.

B (Pin 7): Receiver Input.

A (Pin 8): Receiver Input.

TEST CIRCUITS

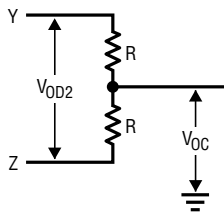

LTC490 • TA02

Figure 1. Driver DC Test Load

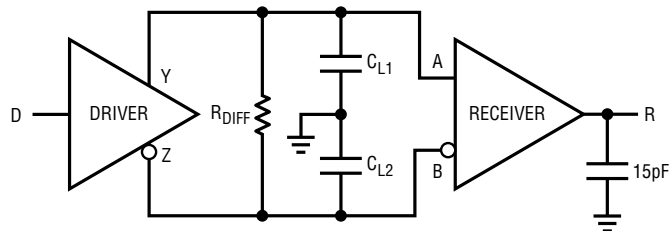

LTC490 • TA03

Figure 2. Driver/Receiver Timing Test Circuit

SWITCHING TIME WAVEFORMS

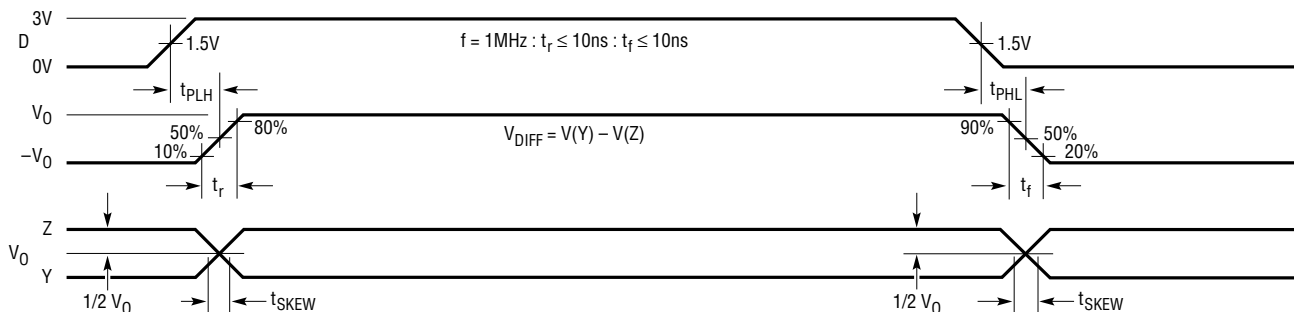

Figure 3. Driver Propagation Delays

LTC490 • TA04

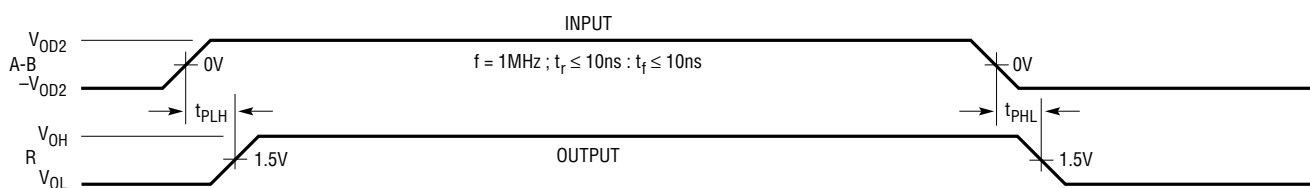

Figure 4. Receiver Propagation Delays

LTC490 • TA05

APPLICATIONS INFORMATION

Typical Application

A typical connection of the LTC490 is shown in Figure 5. Two twisted-pair wires connect two driver/receiver pairs for full duplex data transmission. Note that the driver and receiver outputs are always enabled. If the outputs must be disabled, use the LTC491.

There are no restrictions on where the chips are connected, and it isn't necessary to have the chips connected at the ends of the wire. However, the wires must be terminated only at the ends with a resistor equal to their characteristic impedance, typically 120Ω. Because only

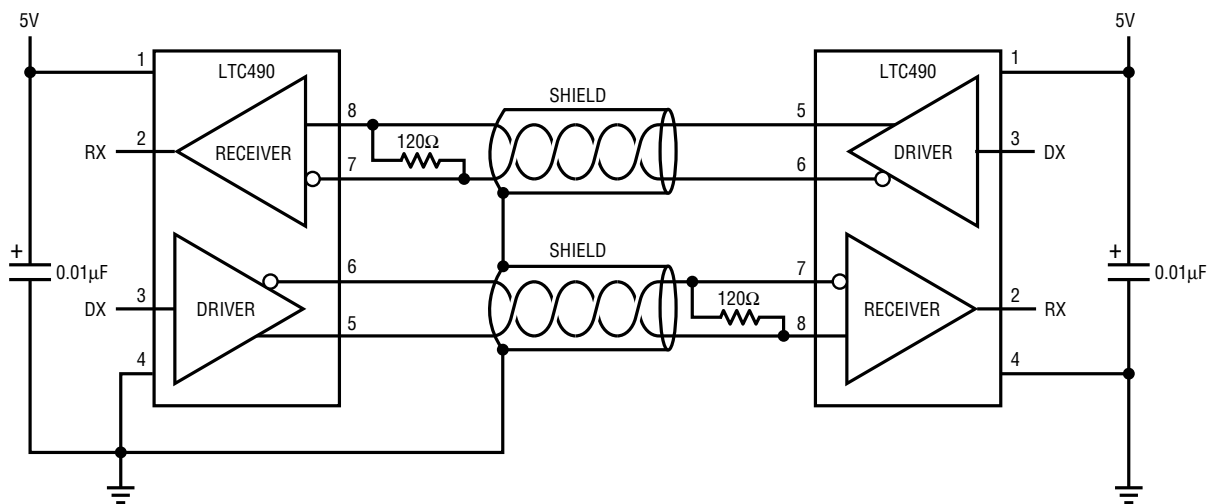

Figure 5. Typical Connection

LTC490 • TA06

APPLICATIONS INFORMATION

one driver can be connected on the bus, the cable can be terminated only at the receiving end. The optional shields around the twisted pair help reduce unwanted noise, and are connected to GND at one end.

The LTC490 can also be used as a line repeater as shown in Figure 6. If the cable length is longer than 4000 feet, the LTC490 is inserted in the middle of the cable with the receiver output connected back to the driver input.

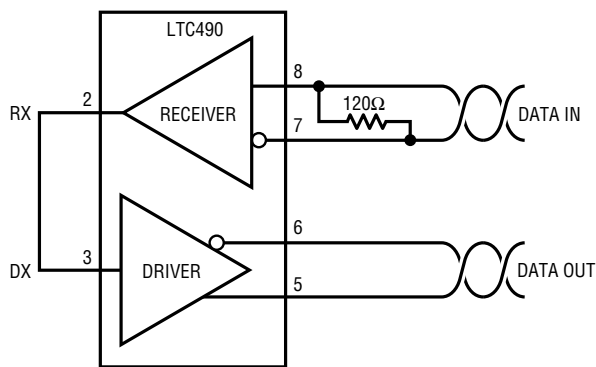

Figure 6. Line Repeater

Thermal Shutdown

The LTC490 has a thermal shutdown feature which protects the part from excessive power dissipation. If the outputs of the driver are accidentally shorted to a power supply or low impedance, source, up to 250mA can flow through the part. The thermal shutdown circuit disables the driver outputs when the internal temperature reaches 150°C and turns them back on when the temperature cools to 130°C. If the outputs of two or more LTC490 drivers are shorted directly, the driver outputs can not supply enough current to activate the thermal shutdown. Thus, the thermal shutdown circuit will not prevent contention faults when two drivers are active on the bus at the same time.

Cables and Data Rate

The transmission line of choice for RS485 applications is a twisted pair. There are coaxial cables (twinaxial) made for this purpose that contain straight pairs, but these are less flexible, more bulky, and more costly than twisted pairs. Many cable manufacturers offer a broad range of 120Ω cables designed for RS485 applications.

Losses in a transmission line are a complex combination of DC conductor loss, AC losses (skin effect), leakage and AC losses in the dielectric. In good polyethylene cables such as the Belden 9841, the conductor losses and dielectric losses are of the same order of magnitude, leading to relatively low overall loss (Figure 7).

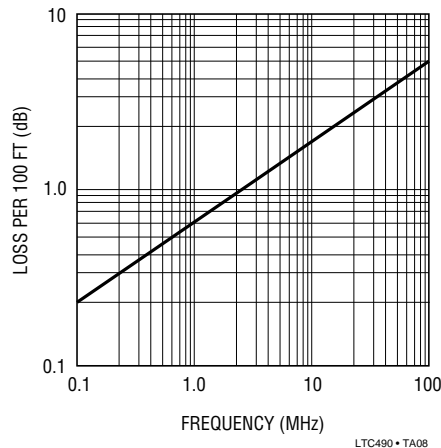

Figure 7. Attenuation vs Frequency for Belden 9841

When using low loss cables, Figure 8 can be used as a guideline for choosing the maximum line length for a given data rate. With lower quality PVC cables, the dielectric loss factor can be 1000 times worse. PVC twisted pairs have terrible losses at high data rates (>100kbs), and greatly reduce the maximum cable length. At low data rates however, they are acceptable and much more economical.

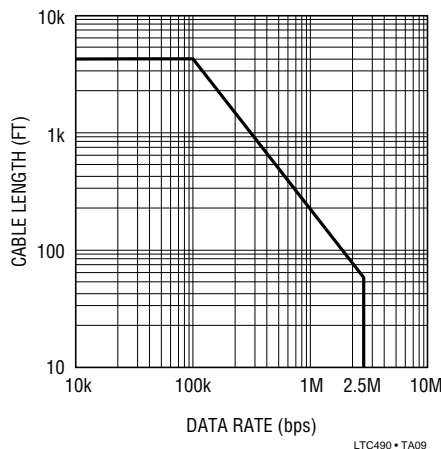

Figure 8. RS485 Cable Length Specification. Applies for 24 Gauge, Polyethylene Dielectric Twisted Pair.

APPLICATIONS INFORMATION

Cable Termination

The proper termination of the cable is very important. If the cable is not terminated with its characteristic impedance, distorted waveforms will result. In severe cases, distorted (false) data and nulls will occur.

A quick look at the output of the driver will tell how well the cable is terminated. It is best to look at a driver connected to the end of the cable, since this eliminates the possibility of getting reflections from two directions. Simply look at the driver output while transmitting square wave data. If the cable is terminated properly, the waveform will look like a square wave (Figure 9). If the cable is loaded excessively (47Ω), the signal initially sees the surge impedance of the cable and jumps to an initial amplitude. The signal travels down the cable and is reflected back out of phase because of the mistermination. When the reflected signal returns to the driver, the amplitude will be lowered. The width of the pedestal is equal to twice the electrical length of the cable (about 1.5ns/foot). If the cable is lightly loaded (470Ω), the signal reflects in phase and increases the amplitude at the driver output. An input frequency of 30kHz is adequate for tests out to 4000 feet of cable.

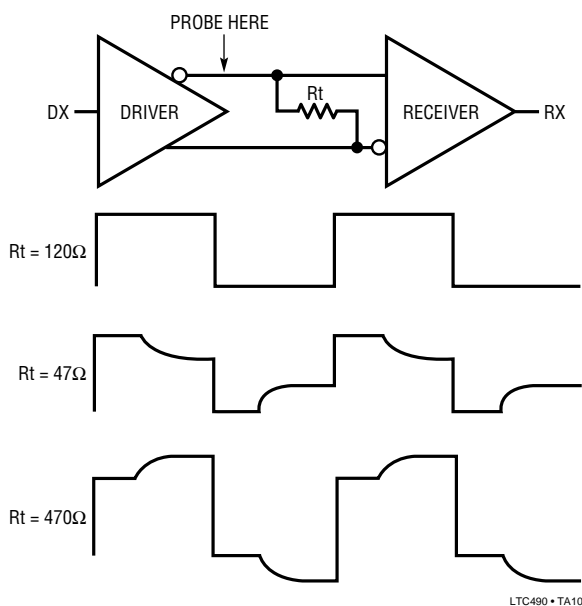

Figure 9. Termination Effects

AC Cable Termination

Cable termination resistors are necessary to prevent unwanted reflections, but they consume power. The typical differential output voltage of the driver is 2V when the cable is terminated with two 120Ω resistors, causing 33mA of DC current to flow in the cable when no data is being sent. This DC current is about 60 times greater than the supply current of the LTC490. One way to eliminate the unwanted current is by AC coupling the termination resistors as shown in Figure 10.

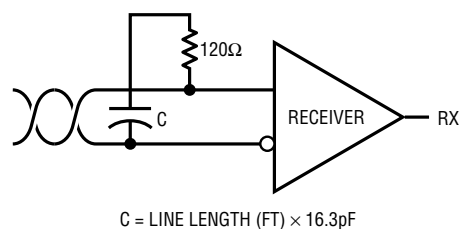

Figure 10. AC Coupled Termination

The coupling capacitor must allow high frequency energy to flow to the termination, but block DC and low frequencies. The dividing line between high and low frequency depends on the length of the cable. The coupling capacitor must pass frequencies above the point where the line represents an electrical one-tenth wavelength. The value of the coupling capacitor should therefore be set at 16.3pF per foot of cable length for 120Ω cables.

With the coupling capacitors in place, power is consumed only on the signal edges, and not when the driver output is idling at a 1 or 0 state. A 100nF capacitor is adequate for lines up to 4000 feet in length. Be aware that the power savings start to decrease once the data rate surpasses $1/(120\Omega \times C)$.

Fault Protection

All of LTC's RS485 products are protected against ESD transients up to 2kV using the human body model (100pF, 1.5k Ω). However, some applications need more protection. The best protection method is to connect a bidirectional TransZorb[®] from each line side pin to ground (Figure 11). A TransZorb[®] is a silicon transient voltage

TransZorb[®] is a registered trademark of General Instruments, GSI

APPLICATIONS INFORMATION

suppressor that has exceptional surge handling capabilities, fast response time, and low series resistance. They are available from General Instruments, GSI and come in a variety of breakdown voltages and prices. Be sure to pick a breakdown voltage higher than the common-mode voltage required for your application (typically 12V). Also, don't forget to check how much the added parasitic capacitance will load down the bus.

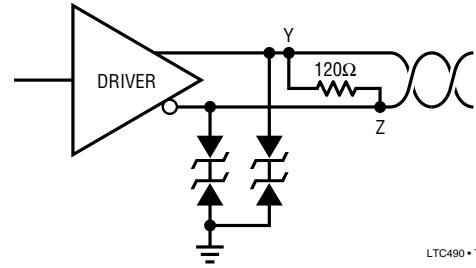

LTC490 • TA12

Figure 11. ESD Protection with TransZorbs®

TYPICAL APPLICATIONS

RS232 Receiver

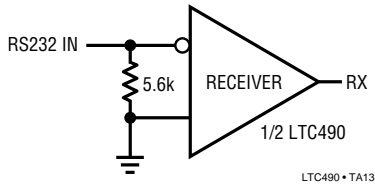

LTC490 • TA13

RS232 to RS485 Level Transistor with Hysteresis

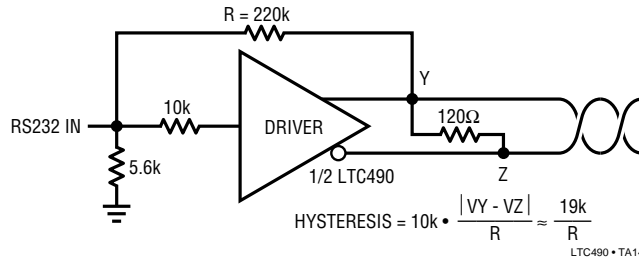

LTC490 • TA14

PACKAGE DESCRIPTION

Dimensions in inches (millimeters) unless otherwise noted.

N8 Package 8-Lead Plastic DIP

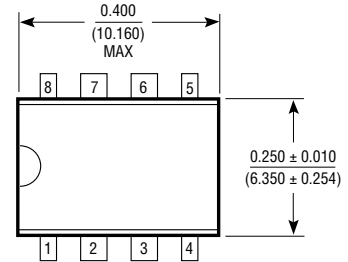
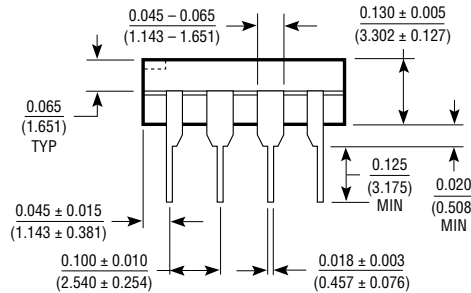
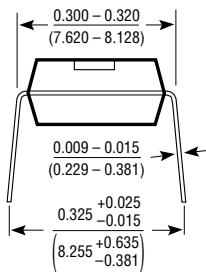

S8 Package 8-Lead Plastic SOIC

