

# QTC3 Series

## 1.5x3.2 SMD Tuning Fork



### Features

- Low frequency in small size SMD
- Seam sealed ceramic package offers excellent environmental & heat resistance
- Extended temperature -40 to +85°C for industrial applications

### Applications

- Commercial and Industrial applications
- Wireless communications
- PDA and Smartphone
- Time of day applications

### General Specifications

Nominal Frequency	32.768kHz
Frequency Tolerance at 25°C	±20ppm
Temperature Coefficient	-0.034 ± 0.008ppm/Δ °C <sup>2</sup>
Temperature Range (Operating)	-40 to +85°C
Storage Temperature	-55 to +125°C
Load Capacitance C <sub>L</sub>	7pF, 9pF, 12.5pF
Shunt Capacitance C <sub>0</sub>	1.7pF typ.
Motional Capacitance C <sub>1</sub>	3.0fF typ.
Equivalent Series Resistance (ESR)	65KΩ max.
Drive Level	1μW max.
Aging per Year	±3ppm max.
Insulation Resistance (M Ω)	500 at 100Vdc ±15Vdc
Quality Factor	70000 typ.
Capacitance Ratio	450 typ.

### Mechanical Dimensions

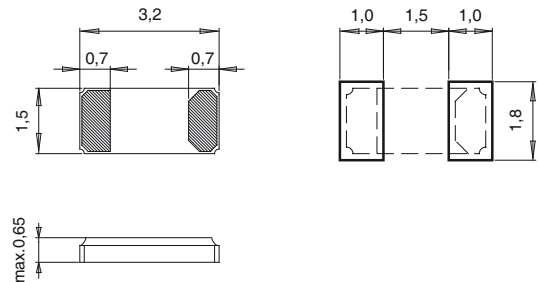

### Part Numbering Guide

Qantek Code	Package	Nominal Frequency (in kHz)	Load Capacitance	Operating Temperature Range	Frequency Tolerance	Packaging
Q = Qantek	TC3 = 1.5x3.2 SMD Tuning Fork	32.768	07 = 7pF 09 = 9pF 12 = 12.5pF	<b>B = -40 to +85°C</b>	1 = ±10ppm 2 = ±20ppm 3 = ±30ppm	R = 3000pcs Tape&Reel

Example: QTC332.76812B2R

bold letters = recommended standard specification

### Tape and Reel Dimensions

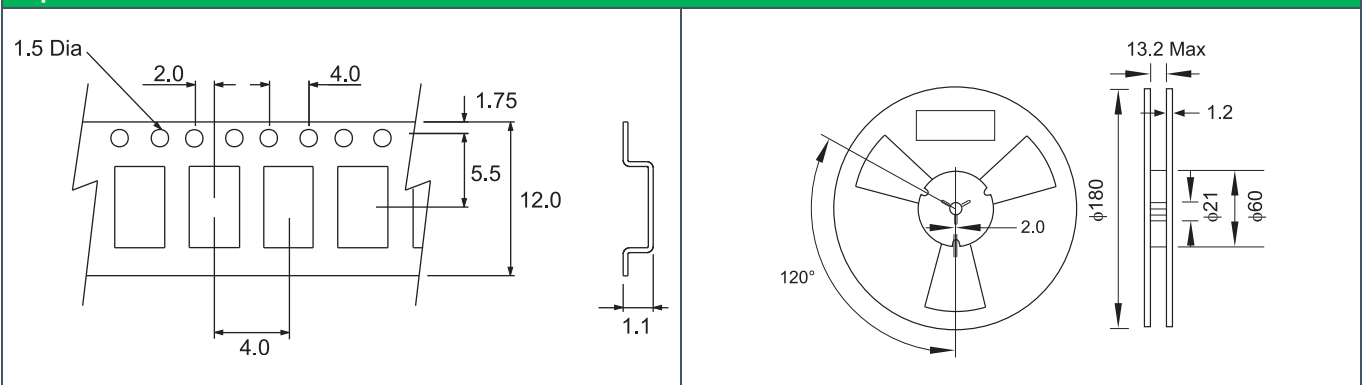

**QANTEK Technology Corporation**

Phone: +1 877-227-0440 (tollfree)

Fax: +1 877-227-0440 (tollfree)

www.qantek.com

info@qantek.com

# QTC3 Series

## 1.5x3.2 SMD Tuning Fork

### Marking Code Guide

Contains manufacturer code / lot code

### Solder Reflow Profile

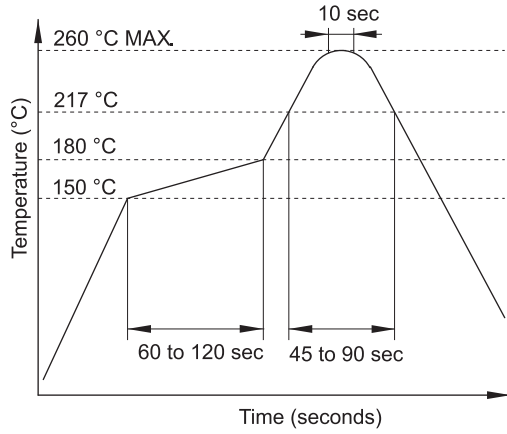

### Frequency vs. Temperature Characteristics

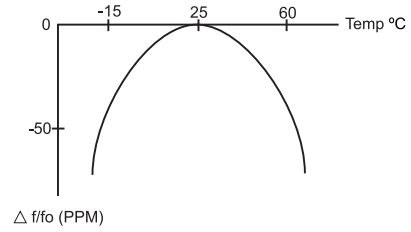

To calculate the frequency stability the parabolic curvature constant (K) is needed. For calculating the stability at 45°C?

1- Change in temperature ( $\Delta T$ ) is  $(45-25) = +20^\circ\text{C}$

2- Change in frequency is  $(-0.034 \times (\Delta^\circ\text{C})^2) = (-0.035 \times (20)^2) = -13.6\text{ppm}$



**QANTEK Technology Corporation**

Phone: +1 877-227-0440 (tollfree)

Fax: +1 877-227-0440 (tollfree)

[www.qantek.com](http://www.qantek.com)

[info@qantek.com](mailto:info@qantek.com)