



DEVICE NUMBER : DPD-063-007 REV : 2.3
ECN : _____ PAGE : 1/7

2.75 x 5.25mm Silicon PIN Photodiode

MODEL NO : _____ PD638B

■ Features :

- Fast response time
- High photo sensitivity
- Small junction capacitance

■ Description :

- PD638B is a high speed and sensitive PIN photodiode in a flat side view plastic package. The epoxy package itself is an IR filter, spectrally matched to GaAs or GaAlAs IR emitter.

■ Applications :

- High speed photo detector
- Camera
- Infrared remote controller for TVs VCR, audio equipment, air conditioner, etc.

PART NO.	CHIP	LENS COLOR
	MATERIAL	
PD	Silicon	Black

2.75 x 5.25mm Silicon PIN Photodiode

MODEL NO : PD638B

Package Dimensions:

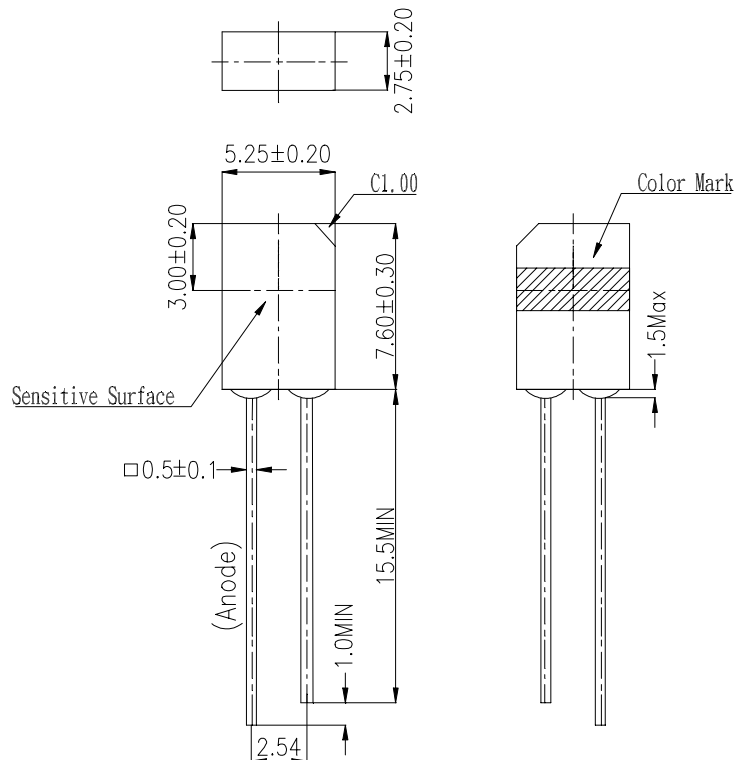

Notes :

1. All dimensions are in millimeter.
2. Protruded resin under flange 1.5 mm Max.
3. Lead spacing is measured where the lead emerge from the package.
4. Lens color : Black.
5. Above specification may be changed without notice. EVERLIGHT will reserve authority on material change for above specification.
6. These specification sheets include materials protected under copyright of EVERLIGHT corporation . Please don't reproduce or cause anyone to reproduce them without EVERLIGHT's consent.
7. When using this product , please observe the absolute maximum ratings and the instructions for use outlined in these specification sheets. EVERLIGHT assumes no responsibility for any damage resulting from use of the product which does not comply with the absolute maximum ratings and the instructions included in these specification sheets.

**2.75 x 5.25mm Silicon PIN Photodiode**MODEL NO : PD638B**■ Absolute Maximum Ratings at T_A = 25°C**

Parameter	Symbol	Rating	Unit	Notice
Reverse Voltage	V _R	32	V	
Power Dissipation	P _d	150	mW	
Lead Soldering Temperature	T _{sol}	260	°C	4mm from mold body less than 5 seconds
Operating Temperature	T _{opr}	-25 ~ +85	°C	
Storage Temperature	T _{stg}	-40 ~ +85	°C	

■ Electronic Optical Characteristics :

Parameter	Symbol	Min.	Typ.	Max.	Unit	Condition
Rang of Spectral Bandwidth	$\lambda_{0.5}$	----	840---1200	----	nm	----
Wavelength of Peak Sensitivity	λ_p	----	980	----	nm	----
Open-Circuit Voltage	V _{OC}	----	0.35	----	V	E _e =5mW/cm ² λ_p =940nm
Short-Circuit Current	I _{SC}	----	80	----	μ A	
Reverse Light Current	I _L	----	80	----	μ A	E _e =5mW/cm ² λ_p =940nm V _R =5V
Dark Current	I _D	----	5	30	nA	E _e =0mW/cm ² V _R =10V
Reverse Breakdown Voltage	B _{VR}	32	170	----	V	E _e =0mW/cm ² I _R =100 μ A
Total Capacitance	C _t	----	25	----	pF	E _e =0mW/cm ² f=1MHZ V _R =3V
Rise/Fall Time	t _r /t _f	----	50/50	----	nS	R _L =1000 Ω V _R =10V



2.75 x 5.25mm Silicon PIN Photodiode

MODEL NO : PD638B

■ Typical Electrical/Optical/Characteristics Curves

Fig. 1 Power Dissipation vs. Ambient Temperature

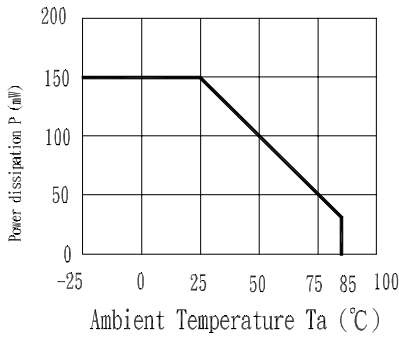

Fig. 2 Spectral Sensitivity

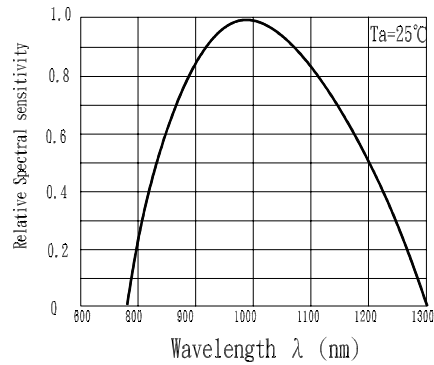

Fig. 3 Dark Current vs. Ambient Temperature

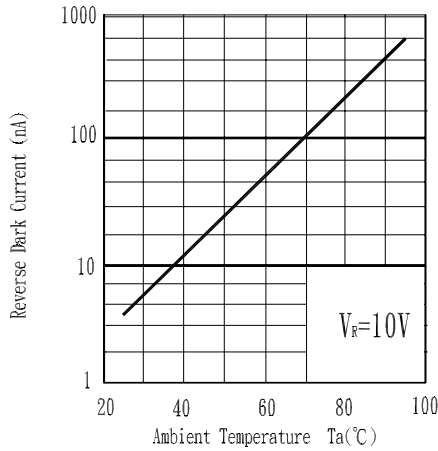

Fig. 4 Reverse Light Current vs. E_e

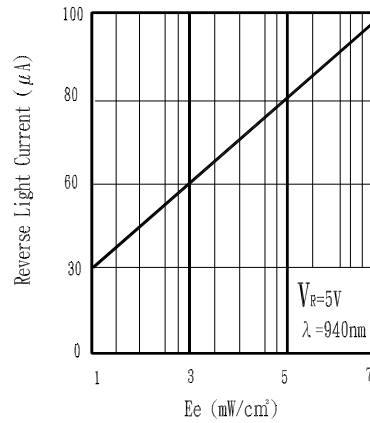

Fig. 5 Terminal Capacitance vs. Reverse Voltage

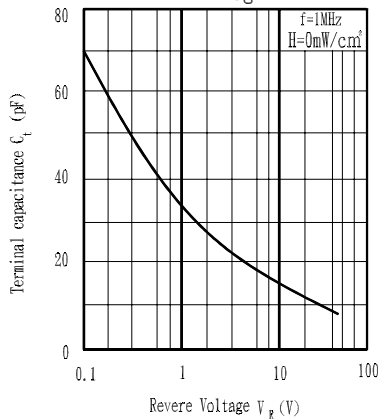
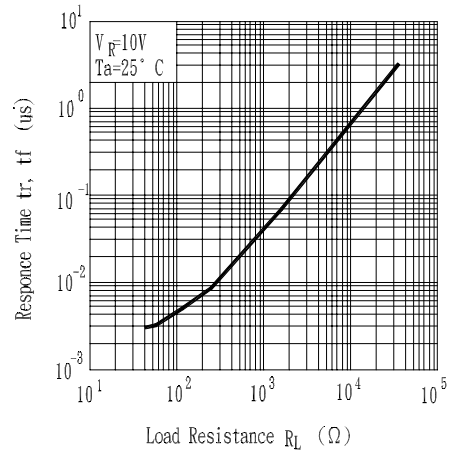

Fig. 6 Response Time vs. Load Resistance





EVERLIGHT ELECTRONICS CO., LTD.

DEVICE NUMBER : DPD-063-007 REV : 2.3
ECN : _____ PAGE : 5/7

2.75 x 5.25mm Silicon PIN Photodiode

MODEL NO : PD638B

■ Reliability Test Item And Condition

The reliability of products shall be satisfied with items listed below.
Confidence level:90%
LTPD:10%

NO.	Item	Test Conditions	Test Hours/ Cycles	Sample Size	Failure Judgement Criteria	Ac/Re
1	Solder Heat	TEMP : 260°C ± 5 °C	5 secs	22 pcs	$I_L \leq L_x \times 0.8$ L :Lower specification limit	0/1
2	Temperature Cycle	H : +85°C 30 mins ↑ 5 mins ↓ L : -55°C 30 mins	50 cycles	22 pcs		0/1
3	Thermal Shock	H : +100°C 5 mins ↑ 10 secs ↓ L : -10°C 5 mins	50 cycles	22 pcs		0/1
4	High Temperature Storage	TEMP. : +100°C	1000 hrs	22 pcs		0/1
5	Low Temperature Storage	TEMP. : -55°C	1000 hrs	22 pcs		0/1
6	DC Operating Life	$V_R=5V$	1000 hrs	22 pcs		0/1
7	High Temperature / High Humidity	85°C / 85% R.H.	1000 hrs	22 pcs		0/1



2.75 x 5.25mm Silicon PIN Photodiode

MODEL NO : PD638B

■ Test Method For Reverse Light Current

Condition: $E_e=5\text{mW}/\text{cm}^2, V_R=5\text{V}$

Test Item: Reverse Light Current)

Unit : μA

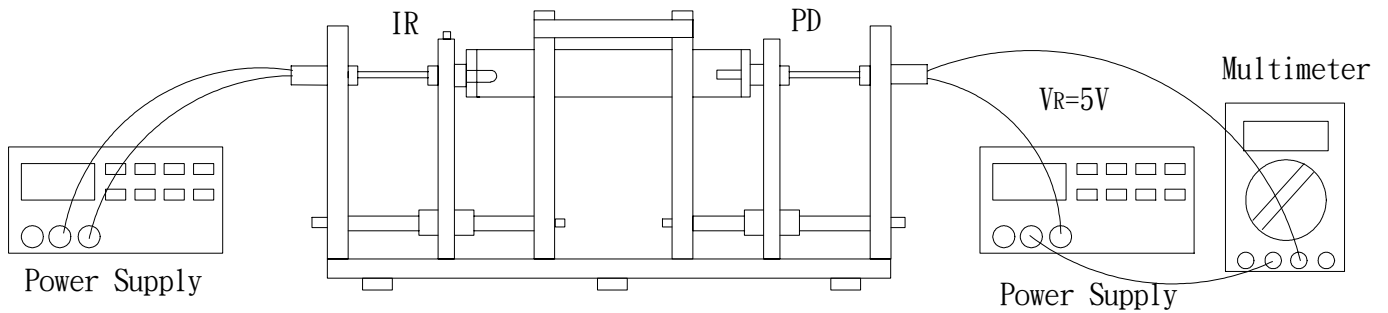



2.75 x 5.25mm Silicon PIN Photodiode

MODEL NO : PD638B

■ Packing Specifications

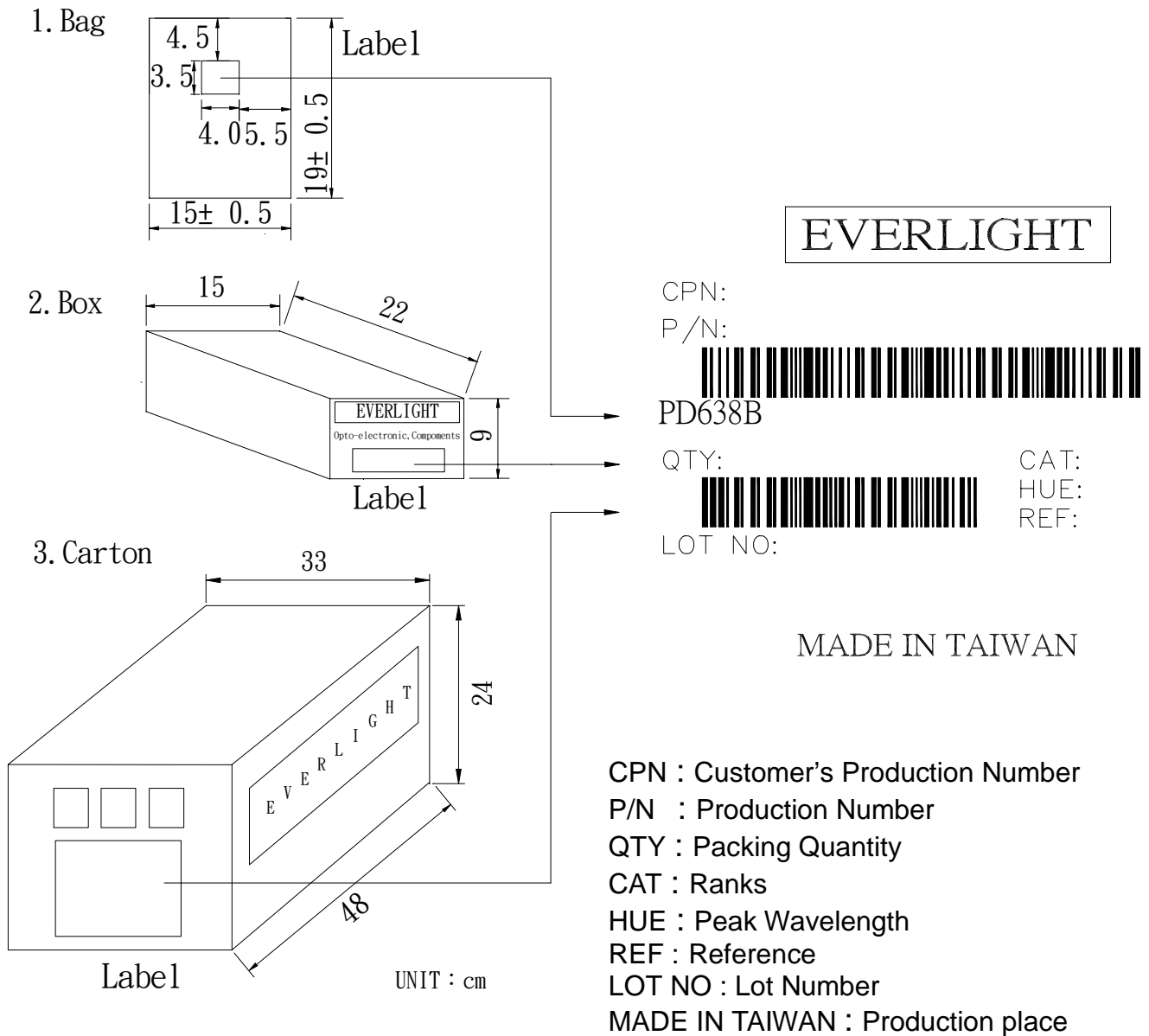

■ Packing Quantity Specification

1. 500 Pcs/1Bag , 10 Bags/1Box
2. 10 Boxes/1Carton