

1.Scope

This specification is applied to Magnetic Buzzer(Self-Drive Type)

The product describe below are used for buzzer in various alarm systems.

2.Basic Condition

- 2.1 Rated Voltage:6VDC
- 2.2 Operating Voltage:4~8VDC
- 2.3 Operating Temperature Range:-20°C ~+70°C
- 2.4 Storage Temperature Range:-30°C~+85°C

3.Electrical Characteristics

- 3.1 Sound Press Level: ≥ 85 dB at 30cm / 6VDC
- 3.2 Consumption Current: ≤ 30 mA at 6VDC
- 3.3 Resonate Frequency:400Hz \pm 100Hz
- 3.4 Tone Nature: Continuous Sound
- 3.5 Material: ABS

4.Measuring Method

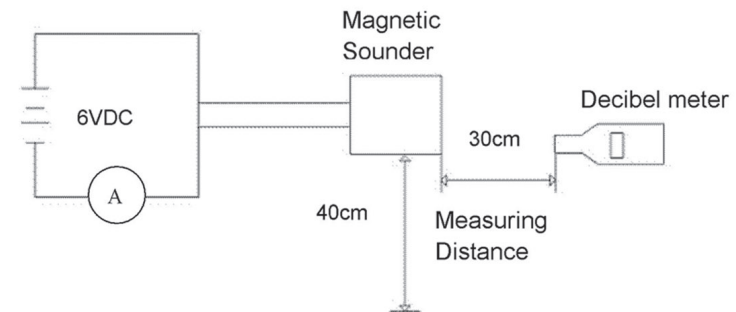

5.Sound Press Level & Consumption Current Curve

