

TACT SWITCH DTS(G)-6 SERIES

6x6 Through Hole & Ground Terminal Type

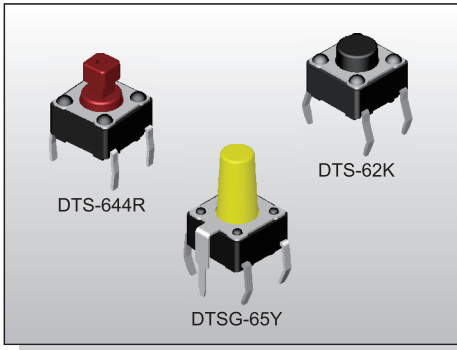

FEATURES

- ✘ Compact size 6x6mm
- ✘ Sharp tactile feeling
- ✘ Cap options

APPLICATION

- ✘ Audio, OA equipment
- ✘ Instrumentation
- ✘ Industrial

SPECIFICATION

Contact Rating	50mA, 12V DC
Contact Resistance	100mΩ max.
Insulation Resistance	100MΩ min. 500V DC
Dielectric Strength	250V AC/1 minute
Operating Force	70±30gf, Blue(U) 100±50gf, Black(K) 160±50gf, Brown(N) 260±50gf, Red(R) 320±80gf, Salmon(S) 520±130gf, Yellow(Y)
Travel	0.25mm
Operating Life	Phosphor Bronze Dome 50,000 cycles for 520/320gf 100,000 cycles for 260gf 200,000 cycles for 160/100/70gf Stainless Steel Dome 300,000 cycles for 520/320gf 500,000 cycles for 260gf 1,000,000 cycles for 160/100/70gf
Operating Temp.	-25°C ~ +70°C
Storage Temp.	-30°C ~ +80°C

HOW TO ORDER

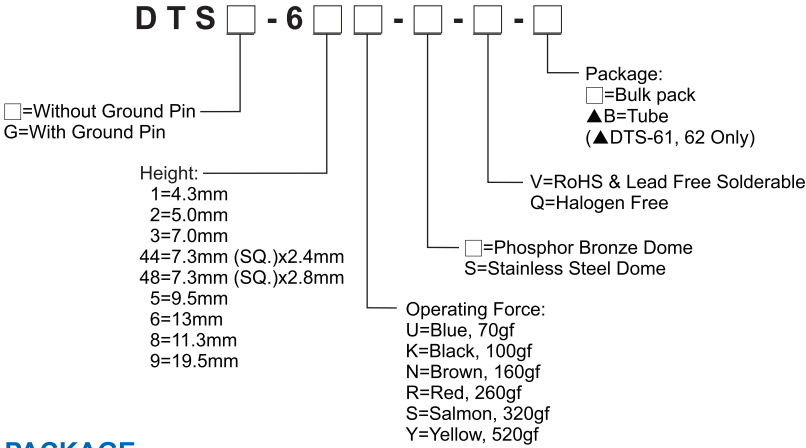

CIRCUIT

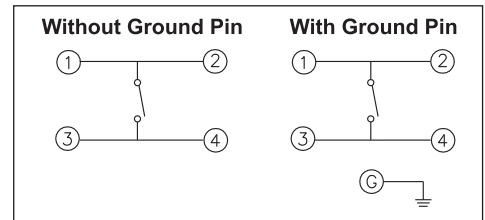

PACKAGE

<Bag>
1000 pcs
<Tub>
DTS-61/62: 75 pcs

DTS-6

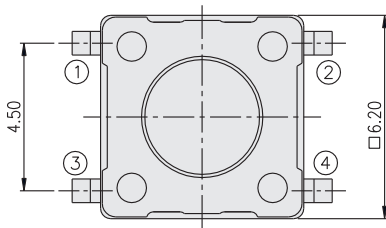

PART NO.	H
DTS-61	4.30
DTS-62	5.00
DTS-63	7.00
DTS-65	9.50
DTS-66	13.00
DTS-68	11.30
DTS-69	19.50

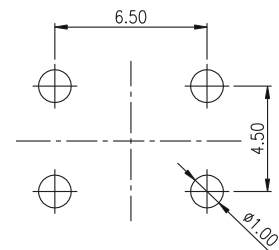
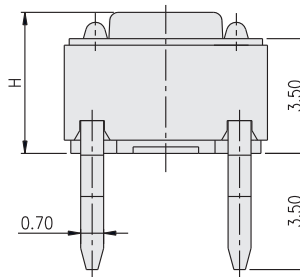
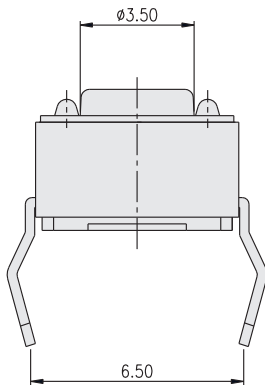

P.C.B. LAYOUT

DTS-644(8)

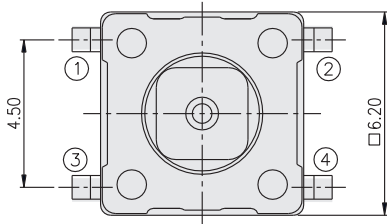

PART NO.	□A	□B
DTS-644	2.40	1.60
DTS-648	2.80	2.00

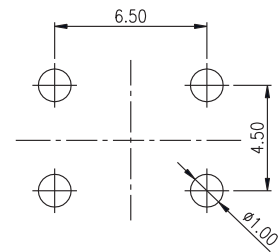
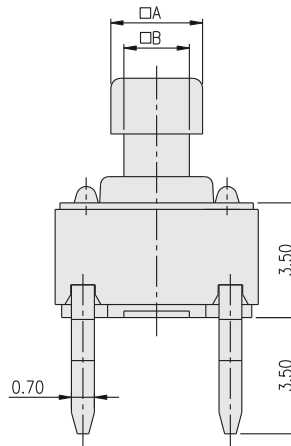
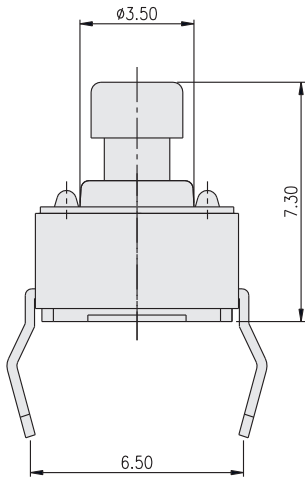

P.C.B. LAYOUT

DTSG-6

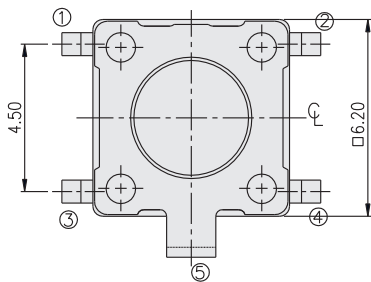

PART NO.	H
DTSG-61	4.30
DTSG-62	5.00
DTSG-63	7.00
DTSG-65	9.50
DTSG-66	13.00
DTSG-68	11.30
DTSG-69	19.50

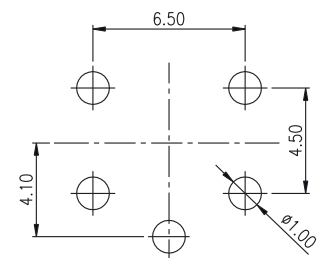
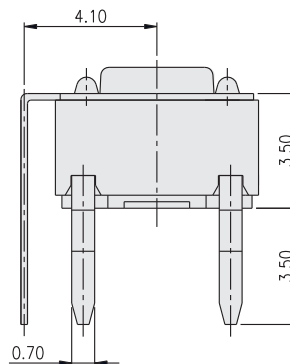
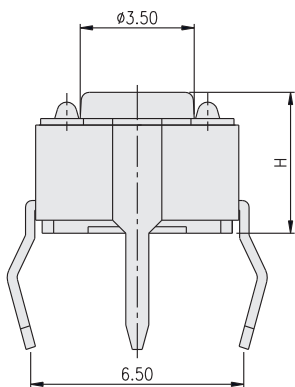

P.C.B. LAYOUT