

Rechargeable AAA-850 (HR03)

AAA

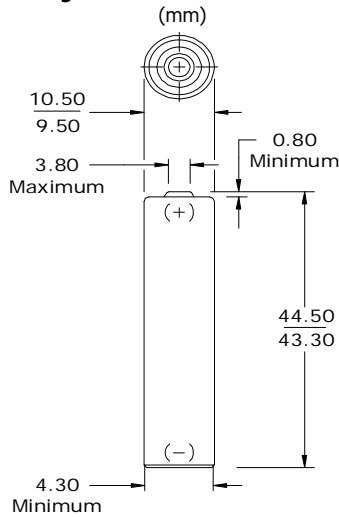

Industry Standard Dimensions



Typical Discharge Characteristics

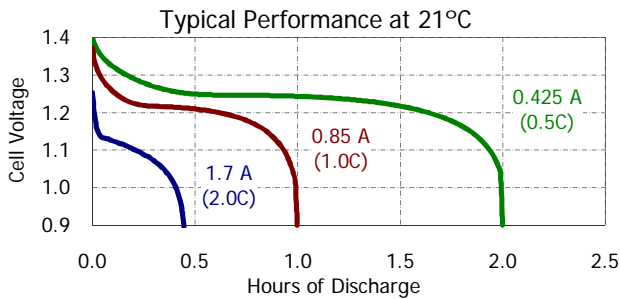
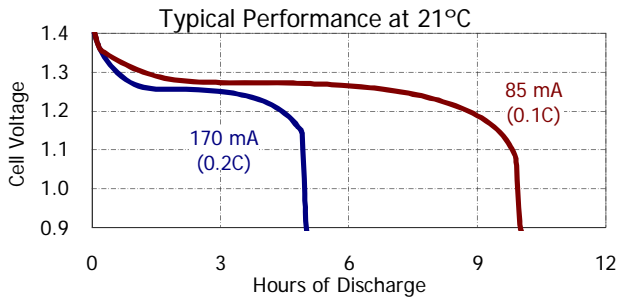

Specifications

Classification:	ACCU Rechargeable
Chemical System:	Nickel-Metal Hydride (NiMH)
Designation:	IEC-HR03
Nominal Voltage:	1.2 Volts
Rated Capacity:	850 mAh (to 1.0 volts) Based on 170 mA (0.2C) discharge rate
Typical Weight:	12.0 grams
Typical Volume:	3.8 cubic centimeters
Jacket:	Plastic Label

Internal Resistance:

The internal resistance of the cell varies with state of charge, as follows:

<u>Cell Charged</u>	<u>Cell 1/2 Discharged</u>
100 milliohms	120 milliohms
(tolerance of ±20% applies to above values)	

AC Impedance (No Load):

The impedance of the charged cell varies with frequency, as follows:

<u>Frequency (Hz)</u>	<u>Impedance (milliohms)</u> (Charged Cell)
1000	35

Above values based on AC current set at 1.0 ampere.
Value tolerances are ±20%.

Operating and Storage Temperatures:

To maintain maximum performance, observe the following general guidelines regarding environmental conditions.

Charge:	0°C to 40°C
Discharge:	0°C to 50°C
Storage:	-20°C to 30°C
Humidity:	65±20%

Operating at extreme temperatures, will significantly impact battery cycle life.

Important Notice

This datasheet contains information specific to battery chargers manufactured at the time of its publication.
©Energizer Holdings, Inc. - Contents herein do not constitute a warranty