

ZPD2.7 ... ZPD75 (500 mW)

Silicon Planar Zener Diodes Silizium-Planar-Zener-Dioden

Version 2012-05-10

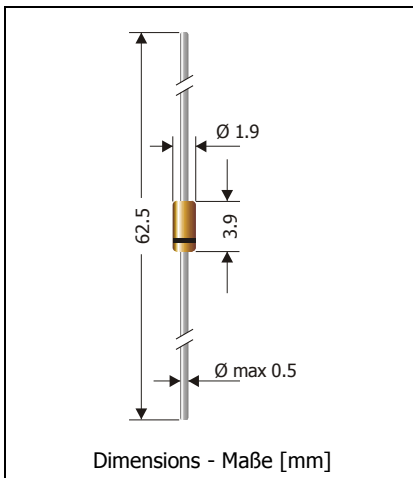

Maximum power dissipation Maximale Verlustleistung	500 mW
Nominal Z-voltage Nominale Z-Spannung	2.7...75 V
Glass case Glasgehäuse	DO-35 (SOD-27)
Weight approx. Gewicht ca.	0.13 g
Equivalent SMD-version Äquivalente SMD-Ausführung	ZMM1 ... ZMM75
Standard packaging taped in ammo pack Standard Lieferform gegurtet in Ammo-Pack	



Standard Zener voltage tolerance is graded to the international E 24 ($\sim \pm 5\%$) standard. Other voltage tolerances and higher Zener voltages on request.

Die Toleranz der Zener-Spannung ist in der Standard-Ausführung gestuft nach der internationalen Reihe E 24 ($\sim \pm 5\%$). Andere Toleranzen oder höhere Arbeitsspannungen auf Anfrage.

Maximum ratings and Characteristics

Grenz- und Kennwerte

		ZPD-series	
Power dissipation Verlustleistung	$T_A = 25^\circ\text{C}$	P_{tot}	500 mW ¹⁾
Operating junction temperature – Sperrschichttemperatur Storage temperature – Lagerungstemperatur		T_j T_s	-50...+175°C -50...+175°C
Thermal resistance junction to ambient air Wärmewiderstand Sperrschicht – umgebende Luft		R_{thA}	< 300 K/W ¹⁾
Thermal resistance junction to lead Wärmewiderstand Sperrschicht – Anschlussdraht		R_{thL}	< 240 K/W

Zener voltages see table on next page – Zener-Spannungen siehe Tabelle auf der nächsten Seite

- Valid, if leads are kept at ambient temperature at a distance of 10 mm from case
Gültig, wenn die Anschlussdrähte in 10 mm Abstand vom Gehäuse auf Umgebungstemperatur gehalten werden
- Tested with pulses – Gemessen mit Impulsen
- The ZPD1 is a diode operated in forward. Hence, the index of all parameters should be "F" instead of "Z".
The cathode, indicated by a band, has to be connected to the negative pole.
Die ZPD1 ist eine in Durchlass betriebene Si-Diode. Daher ist bei allen Kenn- und Grenzwerten der Index "F" anstatt "Z" zu setzen. Die mit einem Balken gekennzeichnete Kathode ist mit dem Minuspol zu verbinden.

Maximum ratings
Grenzwerte

Type Typ	Zener voltage ²⁾ Zener-Spannung ²⁾ I _Z = 5 mA		Dynamic resistance Diff. Widerstand r _{Zj} [Ω] at f = 1 kHz		Temp. Coeffic. of Z-voltage ...der Z-Spannung	Reverse volt. Sperrspanng. I _R = 100 nA	Z-current ¹⁾ Z-Strom ¹⁾ T _A = 25°C
	V _{Zmin} [V]	V _{Zmax} [V]	I _Z = 5 mA	I _Z = 1 mA	α _{VZ} [10 ⁻⁴ /°C]	V _R [V]	I _{Zmax} [mA]
ZPD2.7	2.5	2.9	75 (< 83)	< 500	-9...-4	-	172
ZPD3.0	2.8	3.2	80 (< 95)	< 500	-9...-3	-	156
ZPD3.3	3.1	3.5	80 (< 95)	< 500	-8...-3	-	143
ZPD3.6	3.4	3.8	80 (< 95)	< 500	-8...-3	-	132
ZPD3.9	3.7	4.1	80 (< 95)	< 500	-7...-3	-	122
ZPD4.3	4.0	4.6	70 (< 85)	< 500	-6...-1	-	109
ZPD4.7	4.4	5.0	60 (< 78)	< 500	-5...+2	-	100
ZPD5.1	4.8	5.4	30 (< 60)	< 480	-3...+4	> 0.8	93
ZPD5.6	5.2	6.0	10 (< 40)	< 400	-2...+6	> 1	83
ZPD6.2	5.8	6.6	5 (< 10)	< 200	-1...+7	> 2	76
ZPD6.8	6.4	7.2	4.5 (< 8)	< 150	+2...+7	> 3	69
ZPD7.5	7.0	7.9	4 (< 7)	< 50	+3...+7	> 5	63
ZPD8.2	7.7	8.7	4.5 (< 7)	< 50	+4...+7	> 6	57
ZPD9.1	8.5	9.6	5 (< 10)	< 50	+5...+8	> 7	52
ZPD10	9.4	10.6	5.2 (< 15)	< 70	+5...+8	> 7.5	47
ZPD11	10.4	11.6	6 (< 20)	< 70	+5...+9	> 8.5	43
ZPD12	11.4	12.7	7 (< 20)	< 90	+6...+9	> 9	39
ZPD13	12.4	14.1	9 (< 25)	< 110	+7...+9	> 10	35
ZPD15	13.8	15.6	11 (< 30)	< 110	+7...+9	> 11	32
ZPD16	15.3	17.1	13 (< 40)	< 170	+8...+9.5	> 12	29
ZPD18	16.8	19.1	18 (< 50)	< 170	+8...+9.5	> 14	26
ZPD20	18.8	21.2	20 (< 50)	< 220	+8...+10	> 15	24
ZPD22	20.8	23.3	25 (< 55)	< 220	+8...+10	> 17	21
ZPD24	22.8	25.6	28 (< 70)	< 220	+8...+10	> 18	20
ZPD27	25.1	28.9	30 (< 80)	< 250	+8...+10	> 20	17
ZPD30	28	32	35 (< 80)	< 250	+8...+10	> 22	16
ZPD33	31	35	40 (< 80)	< 250	+8...+10	> 24	14
ZPD36	34	38	40 (< 90)	< 250	+8...+10	> 26	13
ZPD39	37	41	50 (< 90)	< 300	+10...+12	> 28	12
ZPD43	40	46	60 (< 100)	< 500	+10...+12	> 30	11
ZPD47	44	50	70 (< 110)	< 700	+10...+12	> 33	10
ZPD51	48	54	80 (< 125)	< 700	+10...+12	> 36	9
ZPD56	52	60	90 (< 135)	< 750	+10...+12	> 39	8
ZPD62	58	66	100 (< 150)	< 800	+10...+12	> 44	8
ZPD68	64	72	110 (< 200)	< 850	+10...+12	> 48	7
ZPD75	70	79	120 (< 250)	< 900	+10...+12	> 52	6

1 Notes see previous page – Fußnoten siehe vorhergehende Seite