

MATERIALS:

Contacts: Brass T=0.3
 Insulator: PBT, UL94V-0 Rated.

FINISHES:

Contact: Gold Flash

ELECTRICAL CHARACTERISTICS:

Contact Current Rating: 3 Amperes.
 Dielectric Withstanding Voltage: AC500 V r.m.s
 Insulation Resistance: 1000 Megohms Minimum at DC 500V
 Contact Resistance: 15 Milliohms Maximum.
 Operating Temperature: -55°C to +105°C
 1.27mm(0.05 inch) Spacing AWG#28(Standard) or #30(Solid).

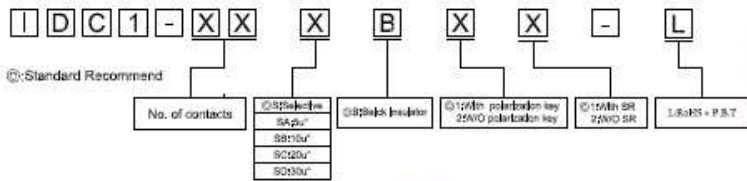

ORDER INFORMATION



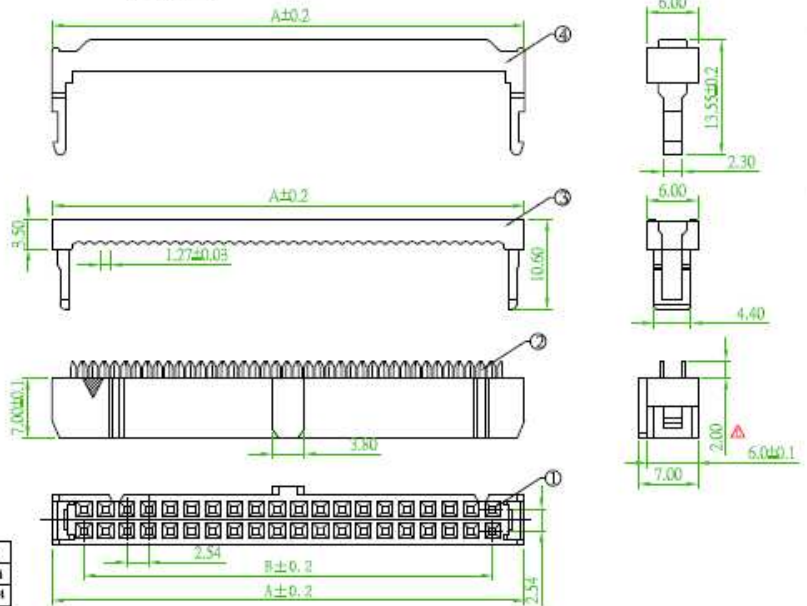
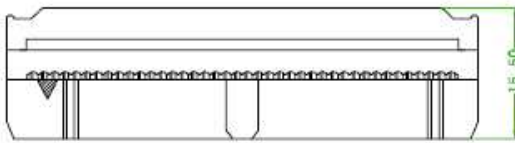

NO.	NAME	MATERIAL	FINISH	QTY
1	HOUSING	PBT	BLACK	1
2	TERMINAL	BRONZE 0.3	GOLD PLATE	SPINS
3	COVER	PBT	BLACK	1
4	BACK COVER	PBT	BLACK	1



SPINS	6P	8P	10P	12P	14P	16P	20P	24P	26P	30P	34P	40P	50P	60P	64P
A	12.18	14.72	17.26	19.80	22.34	24.88	29.96	35.04	37.58	42.66	47.74	55.36	68.06	80.76	85.84
B	5.08	7.62	10.16	12.70	15.24	17.78	22.86	27.94	30.48	35.56	40.64	48.26	60.96	73.66	78.74

 C  B AREA REV. DESCRIPTION DATE	品名	IDC SOCKET 2,54mm				
	品號	IDC1-XX-L			日期	2008/09/17
	圖號	IDC1-XX-L	版本	C	繪圖	
	客戶品號		比例	FREE	核對	
	公差	X ±0.25 XX ±0.13	單位	mm	核准	

	C	Revised the Dim : 2.30→2.00.	
	B	Revised Contact Current Rating: 1 Amperes → 3 Amperes.	