

Aluminum Capacitors Axial Standard, High Voltage

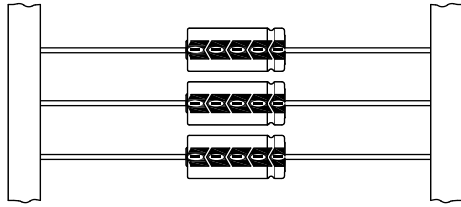
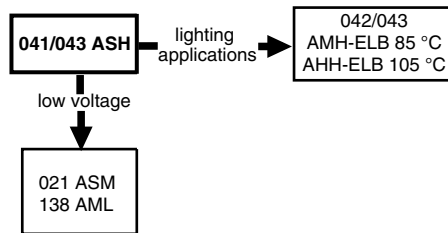

Fig.1 Component outlines

FEATURES

- Polarized aluminum electrolytic capacitors, non-solid electrolyte
- Axial leads, cylindrical aluminum case, insulated with a blue sleeve
- Mounting ring version not available in insulated form
- Taped versions up to case Ø 15 mm x 30 mm available for automatic insertion
- Useful life: 5000 h to 15 000 h at 85 °C
- High rated voltage: up to 450 V
- Compliant to RoHS directive 2002/95/EC

**RoHS
COMPLIANT**
APPLICATIONS

- General purpose, industrial, power supply, audio-video
- Smoothing, filtering, buffering at high voltages
- Boards with restricted mounting height, vibration and shock resistant

MARKING

The capacitors are marked (where possible) with the following information:

- Rated capacitance (in μF)
- Tolerance on rated capacitance, code letter in accordance with IEC 60062 (T for - 10 % to + 50 %)
- Rated voltage (in V)
- Upper category temperature (85 °C)
- Date code, in accordance with IEC 60062
- Code indicating factory of origin
- Name of manufacturer
- Negative terminal identification
- Series number (041, 042 or 043)

QUICK REFERENCE DATA	
DESCRIPTION	VALUE
Nominal case sizes (Ø D x L in mm)	6.5 x 18 to 10 x 25 10 x 30 to 21 x 38
Rated capacitance range, C_R	1 to 220 μF
Tolerance on C_R	- 10 to + 50 %
Rated voltage range, U_R	160 to 450 V
Category temperature range	- 40 °C to + 85 °C (450 V: - 25 °C to + 85 °C)
Endurance test at 85 °C	2000 h 8000 h (450 V: 5000 h)
Useful life at 85 °C	5000 h 15 000 h (450 V: 10 000 h)
Useful life at 40 °C	1.4 x I_R applied: 120 000 h 1.8 x I_R applied: 240 000 h (450 V: 160 000 h)
Shelf life at 0 V, 85 °C	500 h 500 h
Based on sectional specification	IEC 60384-4/EN130300
Climatic category IEC 60068	40/085/56 (450 V: 25/085/56)

SELECTION CHART FOR C_R , U_R AND RELEVANT NOMINAL CASE SIZES (Ø D x L in mm)						
C_R (μF)	U_R (V)					
	160	250	350	385	400	450
1.0	-	-	-	6.5 x 18	-	-
2.2	-	6.5 x 18	-	8 x 18	-	-
4.7	6.5 x 18	8 x 18	10 x 18	10 x 25	-	-
6.8	-	-	10 x 30	10 x 30	10 x 30	10 x 30
10	8 x 18	10 x 25	12.5 x 30	12.5 x 30	12.5 x 30	12.5 x 30
15	-	10 x 30	-	-	-	-
22	-	12.5 x 30	12.5 x 30	15 x 30	15 x 30	12.5 x 30
33	10 x 25	12.5 x 30	15 x 30	18 x 30	18 x 30	15 x 30
47	10 x 30	-	-	-	-	-
68	12.5 x 30	15 x 30	18 x 30	18 x 38	18 x 38	18 x 30
100	15 x 30	18 x 30	18 x 38	18 x 38	18 x 38	18 x 38
150	15 x 30	18 x 38	21 x 38	21 x 38	21 x 38	21 x 38
220	18 x 30	21 x 38	-	-	-	-
	18 x 38	-	-	-	-	-
	21 x 38	-	-	-	-	-

DIMENSIONS in millimeters **AND AVAILABLE FORMS**

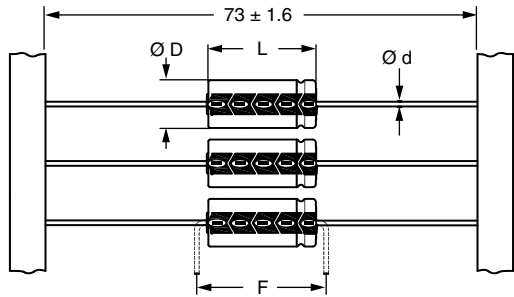

Form BR: Taped on reel
Case $\varnothing D \times L = 6.5 \text{ mm} \times 18 \text{ mm}$ to $15 \text{ mm} \times 30 \text{ mm}$
Form BA: Taped in box (ammopack)
Case $\varnothing D \times L = 6.5 \text{ mm} \times 18 \text{ mm}$ to $10 \text{ mm} \times 25 \text{ mm}$

Fig.2 Forms BA and BR

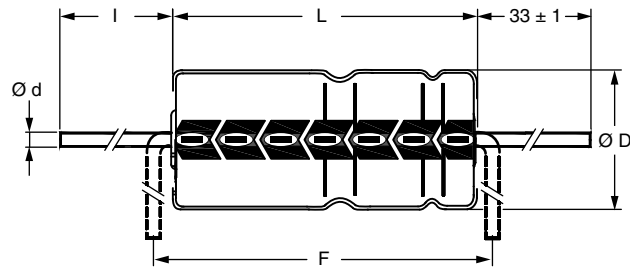

Form AA: Axial in box
Case $\varnothing D \times L = 10 \text{ mm} \times 30 \text{ mm}$ to $21 \text{ mm} \times 38 \text{ mm}$

Fig.3 Form AA

Table 1

AXIAL; DIMENSIONS in millimeters, MASS AND PACKAGING QUANTITIES										
NOMINAL CASE SIZE $\varnothing D \times L$	CASE CODE	AXIAL: FORM AA, BA, AND BR					MASS (g)	PACKAGING QUANTITIES		
		$\varnothing d$	l	$\varnothing D_{max.}$	$L_{max.}$	$F_{min.}$		FORM AA	FORM BA	FORM BR
6.5 x 18	4	0.8	-	6.9	18.5	25	≈ 1.3	-	1000	1000
8 x 18	5	0.8	-	8.5	18.5	25	≈ 1.7	-	500	500
10 x 18	6	0.8	-	10.5	18.5	25	≈ 2.5	-	500	500
10 x 25	7	0.8	-	10.5	25.5	30	≈ 3.3	-	500	500
10 x 30	00	0.8	55 ± 1	10.5	30.5	35	≈ 4.8	340	-	500
12.5 x 30	01	0.8	55 ± 1	13.0	30.5	35	≈ 7.4	260	-	400
15 x 30	02	0.8	55 ± 1	15.5	30.5	35	≈ 11.7	200	-	250
18 x 30	03	0.8	55 ± 1	18.5	30.5	35	≈ 12.9	120	-	-
18 x 38	04	0.8	34 ± 1	18.5	39.5	44	≈ 19.0	125	-	-
21 x 38	05	0.8	34 ± 1	21.5	39.5	44	≈ 24.0	100	-	-

Note

Detailed tape dimensions see section 'PACKAGING'.

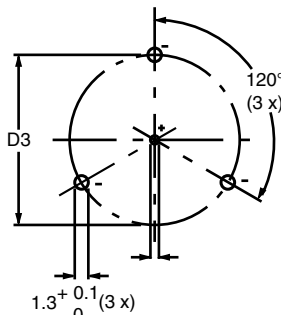

Form MR:
Case $\varnothing D \times L = 15 \text{ mm} \times 30 \text{ mm}$ to $21 \text{ mm} \times 38 \text{ mm}$
Especially for applications with severe shocks and vibrations

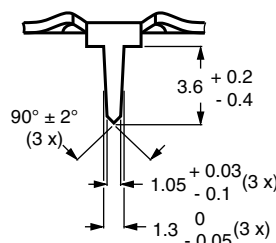

Fig.4 Mounting hole diagram and outline. **Form MR:** with mounting ring and pins

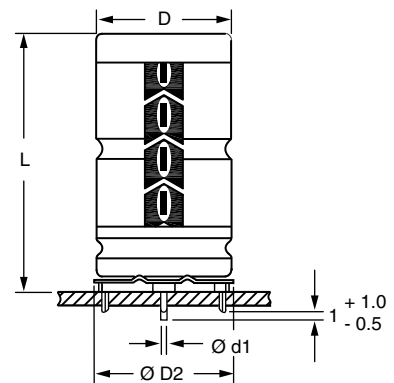

Table 2

MOUNTING RING; DIMENSIONS in millimeters, MASS AND PACKAGING QUANTITIES										
Nominal CASE SIZE $\varnothing D \times L$	CASE code	MOUNTING RING: Form MR						MASS (g)	PACKAGING QUANTITIES	
		$\varnothing d1$	$\varnothing d2$	$\varnothing D_{max.}$	$\varnothing D2_{max.}$	D3	$L_{max.}$			
15 x 30	02	0.8	$1.0 + 0.4$	15.5	17.5	16.5 ± 0.2	33	≈ 11.7	200	
18 x 30	03	0.8	$1.0 + 0.4$	18.5	19.5	18.5 ± 0.2	33	≈ 12.9	240	
18 x 38	04	0.8	$1.0 + 0.4$	18.5	19.5	18.5 ± 0.2	42	≈ 19.0	100	
21 x 38	05	0.8	$1.0 + 0.4$	21.5	22.5	21.5 ± 0.2	42	≈ 24.0	100	



Aluminum Capacitors
Axial Standard, High Voltage

Vishay BCcomponents

ELECTRICAL DATA	
SYMBOL	DESCRIPTION
C _R	rated capacitance at 100 Hz, tolerance - 10 to + 50
I _R	rated RMS ripple current at 100 Hz, 85 °C
I _{L1}	max. leakage current after 1 min at U _R
I _{L5}	max. leakage current after 5 min at U _R
tan δ	max. dissipation factor at 100 Hz
ESR	equivalent series resistance at 100 Hz (calculated from tan δ _{max} and C _R)
Z	max. impedance at 10 kHz

ORDERING EXAMPLE

Electrolytic capacitor 041 series

10 µF/250 V; - 10 %/+ 50 %

Nominal case size: Ø 10 mm x 25 mm; Form BA

Ordering code: MAL204133109E3

Former 12NC: 2222 041 33109

Note

Unless otherwise specified, all electrical values in table 3 apply at T_{amb} = 20 °C, P = 86 kPa to 106 kPa, RH = 45 % to 75 %.

ELECTRICAL DATA AND ORDERING INFORMATION											ORDERING CODE MAL2.....			
U _R (V)	C _R 100 Hz (µF)	NOMINAL CASE SIZE Ø D x L (mm)	CASE CODE	I _R 100 Hz 85 °C (mA)	I _{L1} 1 min (µA)	I _{L5} 5 min (µA)	tan δ 100 Hz	ESR 100 Hz (Ω)	Z 10 kHz (Ω)	IN BOX FORM AA	TAPED ON REEL FORM BR	TAPED IN BOX FORM BA	MOUNTING RING FORM MR	
160	4.7	6.5 x 18	4	50	38	8	0.15	51	26	-	04121478E3	04131478E3	-	
	10	8 x 18	5	70	68	14	0.15	24	12	-	04121109E3	04131109E3	-	
	22	10 x 25	7	150	130	25	0.15	11	5.5	-	04121229E3	04131229E3	-	
	22	10 x 30	00	190	42	25	0.10	6.8	5.5	04211229E3	04221229E3	-	-	
	33	12.5 x 30	01	270	58	36	0.10	4.5	3.1	04211339E3	04221339E3	-	-	
	47	15 x 30	02	350	78	49	0.10	3.2	2.1	04211479E3	04221479E3	-	04241479E3	
	68	15 x 30	02	420	110	69	0.10	2.2	1.4	04211689E3	04221689E3	-	04241689E3	
	100	18 x 30	03	580	150	100	0.10	1.5	1.0	04211101E3	-	-	04241101E3	
	150	18 x 38	04	760	230	150	0.10	1.0	0.7	04311151E3	-	-	04341151E3	
220	21 x 38	05	940	330	220	0.10	0.7	0.5	04311221E3	-	-	04341221E3		
250	2.2	6.5 x 18	4	35	28	6	0.10	72	50	-	04123228E3	04133228E3	-	
	4.7	8 x 18	5	55	55	11	0.10	34	23	-	04123478E3	04133478E3	-	
	10	10 x 25	7	90	95	19	0.10	16	11	-	04123109E3	04133109E3	-	
	10	10 x 30	00	130	33	19	0.10	15	11	04213109E3	04223109E3	-	-	
	15	12.5 x 30	01	180	44	27	0.10	10	7.4	04213159E3	04223159E3	-	-	
	22	12.5 x 30	01	220	60	37	0.10	6.8	5.0	04213229E3	04223229E3	-	-	
	33	15 x 30	02	290	84	54	0.10	4.5	3.4	04213339E3	04223339E3	-	04243339E3	
	47	18 x 30	03	400	120	75	0.10	3.2	2.3	04213479E3	-	-	04243479E3	
	68	18 x 38	04	520	160	110	0.10	2.2	1.7	04313689E3	-	-	04343689E3	
100	21 x 38	05	650	240	150	0.10	1.5	1.1	04313101E3	-	-	04343101E3		
350	4.7	10 x 18	6	60	69	14	0.10	34	22	-	04125478E3	04135478E3	-	
	6.8	10 x 30	00	110	32	18	0.10	22	14	04215688E3	04225688E3	-	-	
	10	12.5 x 30	01	150	42	25	0.10	15	10	04215109E3	04225109E3	-	-	
	15	12.5 x 30	01	180	57	36	0.10	10	6.7	04215159E3	04225159E3	-	-	
	22	15 x 30	02	250	79	50	0.10	6.8	4.5	04215229E3	04225229E3	-	04245229E3	
	33	18 x 30	03	350	110	73	0.10	4.5	3.1	04215339E3	-	-	04245339E3	
	47	18 x 38	04	450	160	100	0.10	3.2	2.1	04315479E3	-	-	04345479E3	
68	21 x 38	05	560	220	150	0.10	2.2	1.4	04315689E3	-	-	04345689E3		
385	1	6.5 x 18	4	20	19	4	0.10	160	100	-	04128108E3	04138108E3	-	
	2.2	8 x 18	5	40	42	8	0.10	72	45	-	04128228E3	04138228E3	-	
	4.7	10 x 25	7	70	71	15	0.10	34	22	-	04128478E3	04138478E3	-	
	6.8	10 x 30	00	110	34	20	0.10	22	14	04218688E3	04228688E3	-	-	
	10	12.5 x 30	01	150	45	27	0.10	15	10	04218109E3	04228109E3	-	-	
	15	15 x 30	02	210	62	39	0.10	10	6.0	04218159E3	04228159E3	-	04248159E3	
	22	18 x 30	03	290	86	55	0.10	6.8	4.1	04218229E3	-	-	04248229E3	
	33	18 x 38	04	380	120	80	0.10	4.5	2.7	04318339E3	-	-	04348339E3	
	47	18 x 38	04	450	170	110	0.10	3.2	2.1	04318479E3	-	-	04348479E3	
68	21 x 38	05	570	250	160	0.10	2.2	1.4	04318689E3	-	-	04348689E3		

ELECTRICAL DATA AND ORDERING INFORMATION

U _R (V)	C _R 100 Hz (μF)	NOMINAL CASE SIZE Ø D x L (mm)	CASE CODE	I _R 100 Hz 85 °C (mA)	I _{L1} 1 min (μA)	I _{L5} 5 min (μA)	tan δ 100 Hz	ESR 100 Hz (Ω)	Z 10 kHz (Ω)	ORDERING CODE MAL2.....			
										IN BOX FORM AA	TAPED ON REEL FORM BR	TAPED IN BOX FORM BA	MOUNTING RING FORM MR
400	6.8	10 x 30	00	110	220	110	0.055	11.5	7.3	04216688E3	04226688E3	-	-
	10	12.5 x 30	01	150	240	110	0.055	7.5	4.6	04216109E3	04226109E3	-	-
	15	15 x 30	02	210	250	110	0.055	5.0	3.1	04216159E3	04226159E3	-	04246159E3
	22	18 x 30	03	290	280	120	0.055	3.5	2.1	04216229E3	-	-	04246229E3
	33	18 x 38	04	380	320	130	0.055	2.3	1.4	04316339E3	-	-	04346339E3
	47	18 x 38	04	450	370	140	0.055	1.7	1.1	04316479E3	-	-	04346479E3
68	21 x 38	05	560	440	150	0.055	1.2	0.7	04316689E3	-	-	04346689E3	
450	6.8	10 x 30	00	110	230	110	0.10	22	14	04217688E3	04227688E3	-	-
	10	12.5 x 30	01	150	240	110	0.10	15	10	04217109E3	04227109E3	-	-
	15	12.5 x 30	01	180	260	110	0.10	10	6.0	04217159E3	04227159E3	-	-
	22	15 x 30	02	240	290	120	0.10	6.8	4.1	04217229E3	04227229E3	-	04247229E3
	33	18 x 30	03	350	330	130	0.10	4.5	2.7	04217339E3	-	-	04247339E3
	47	18 x 38	04	440	390	140	0.10	3.2	2.1	04317479E3	-	-	04347479E3
68	21 x 38	05	550	460	160	0.10	2.2	1.4	04317689E3	-	-	04347689E3	

ADDITIONAL ELECTRICAL DATA

PARAMETER	CONDITIONS	VALUE		
		AXIAL	MOUNTING RING	
Voltage				
Surge voltage	U _R = 160 V to 250 V	U _s ≤ 1.15 x U _R		
	U _R = 350 V to 450 V	U _s ≤ 1.1 x U _R		
Reverse voltage		U _{rev} ≤ 1 V		
Current				
Leakage current	After 1 min: case Ø D x L = 6.5 mm x 18mm to 10 mm x 25 mm: CV ≤ 1000 μC CV > 1000 μC case Ø D x L = 10 mm x 30 mm to 21 mm x 38 mm: U _R = 160 V to 385 V U _R = 400 V and 450 V	I _{L1} ≤ 0.05 C _R x U _R or 5 μA, whichever is greater I _{L1} ≤ 0.03 C _R x U _R + 20 μA I _{L1} ≤ 0.009 C _R x U _R + 10 μA I _{L1} ≤ 0.009 C _R x U _R + 200 μA		
	After 5 minutes: U _R = 160 V to 385 V: CV ≤ 1000 μC CV > 1000 μC U _R = 400 V and 450 V	I _{L5} ≤ 0.01 C _R x U _R or 1 μA, whichever is greater I _{L5} ≤ 0.006 C _R x U _R + 4 μA I _{L5} ≤ 0.002 C _R x U _R + 100 μA		
Inductance				
Equivalent series inductance (ESL)	case Ø D x L mm:			
		6.5 x 18	typ. 15 nH	-
		8 x 18	typ. 35 nH	-
		10 x 18	typ. 69 nH	-
		10 x 25	typ. 38 nH	-
		10 x 30	typ. 38 nH	-
		12.5 x 30	typ. 46 nH	-
		15 x 30	typ. 48 nH	typ. 39 nH
		18 x 30	typ. 50 nH	typ. 39 nH
	18 x 38	typ. 54 nH	typ. 39 nH	
	21 x 38	typ. 59 nH	typ. 39 nH	

CAPACITANCE (C)

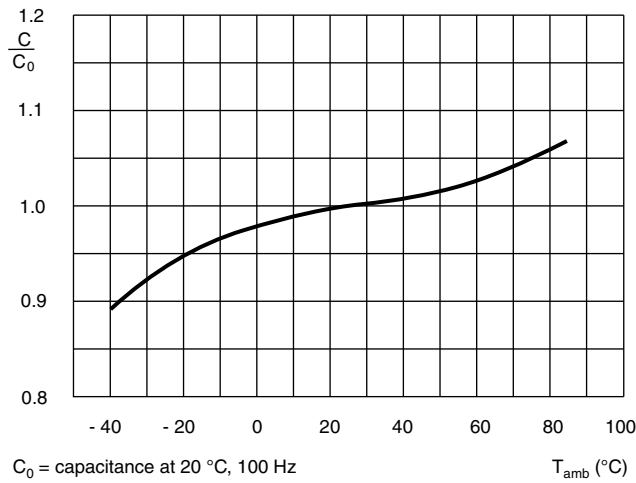

Fig.5 Typical multiplier of capacitance as a function of ambient temperature

EQUIVALENT SERIES RESISTANCE (ESR)

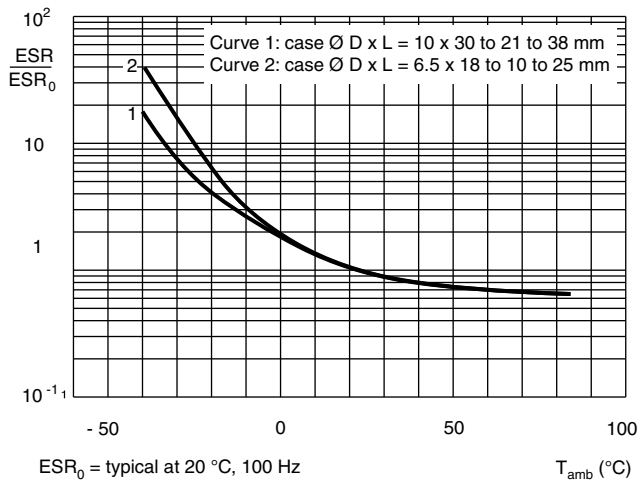

Fig.6 Typical multiplier of ESR as a function of ambient temperature

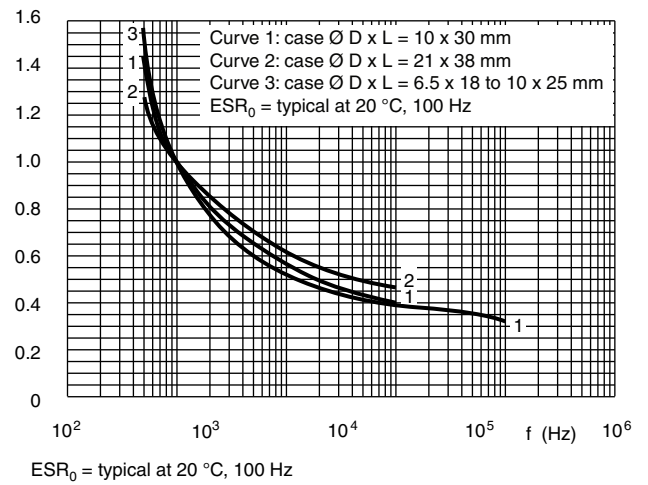

Fig.7 Typical multiplier of ESR as a function of frequency

IMPEDANCE (Z)

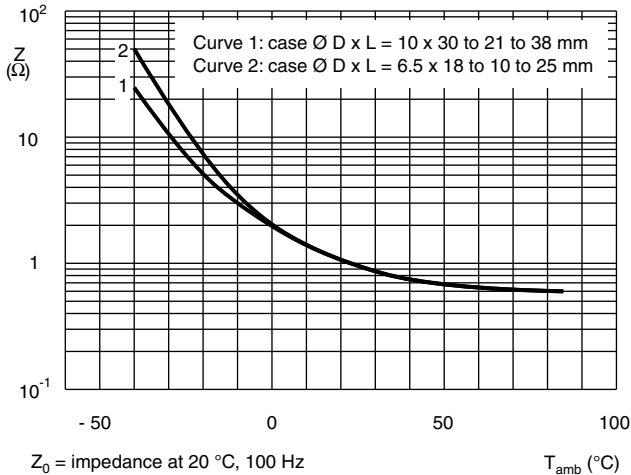

Fig.8 Typical impedance of capacitance as a function of ambient temperature

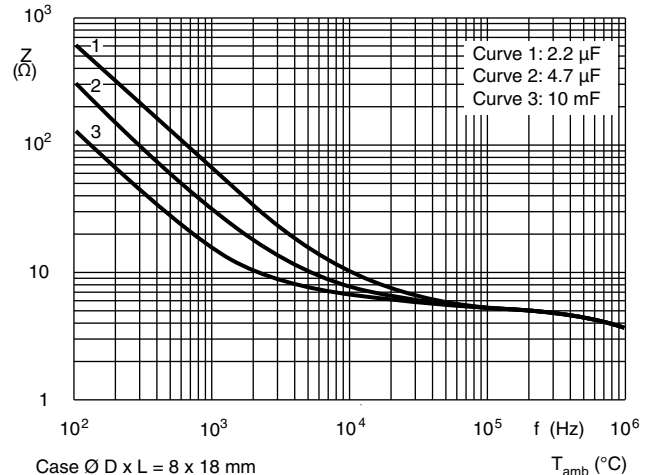

Fig.9 Typical impedance as a function of frequency

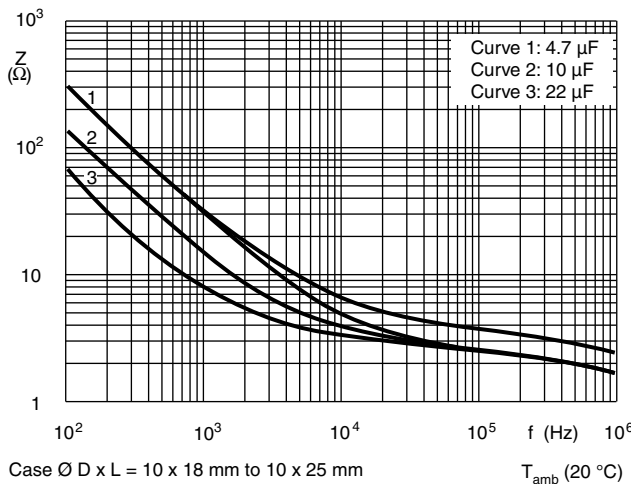

Fig.10 Typical impedance as a function of frequency

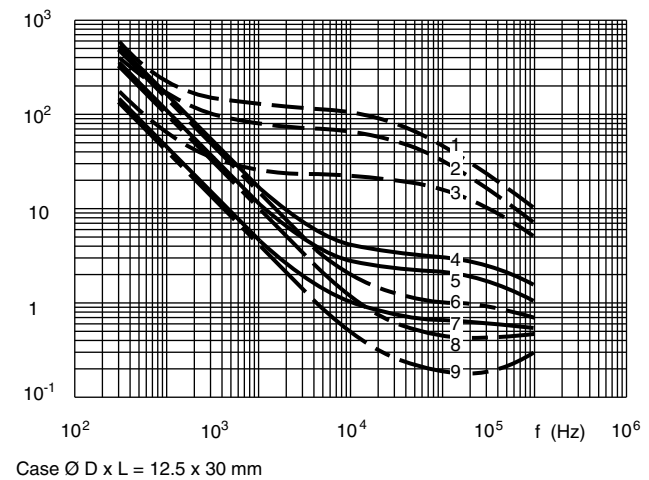

Fig.11 Typical impedance as a function of frequency at different ambient temperatures

- Curve 1: 10 µF, 350 and 385 V; - 40 °C
- Curve 2: 15 µF, 250 V; - 40 °C
- Curve 3: 33 µF, 160 V; - 40 °C
- Curve 4: 10 µF, 350 and 385 V; 20 °C
- Curve 5: 15 µF, 250 V; 20 °C
- Curve 6: 33 µF, 160 V; 20 °C
- Curve 7: 10 µF, 350 and 385 V; 85 °C
- Curve 8: 15 µF, 250 V; 85 °C
- Curve 9: 33 µF, 160 V; 85 °C

RIPPLE CURRENT AND USEFUL LIFE

CCC205

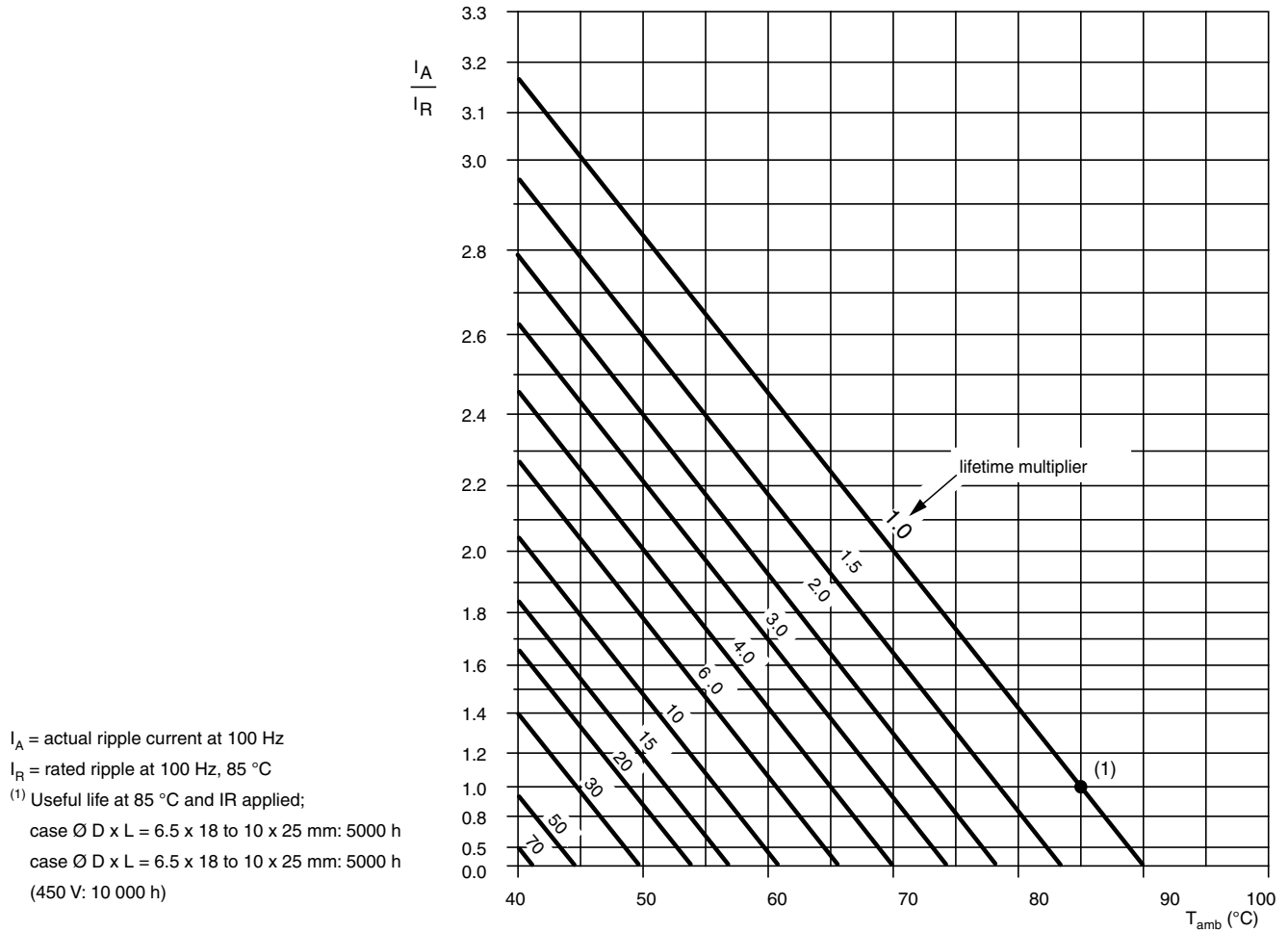

Fig.12 Multiplier of useful life as a function of ambient temperature and ripple current load

Table 3

MULTIPLIER OF RIPPLE CURRENT (I_R) AS A FUNCTION OF FREQUENCY	
FREQUENCY (Hz)	I_R MULTIPLIER
50	0.75
100	1.00
300	1.15
1000	1.30
3000	1.40
$\geq 10\ 000$	1.50

Table 4

TEST PROCEDURES AND REQUIREMENTS			
TEST		PROCEDURE (quick reference)	REQUIREMENTS
NAME OF TEST	REFERENCE		
Endurance	IEC 60384-4/ EN130300 subclause 4.13	$T_{amb} = 85\text{ }^{\circ}\text{C}$; U_R applied; case $\varnothing D \times L$: 6.5 x 18 to 10 x 25 mm: 2000 h; 10 mm x 30 mm to 21 mm x 38 mm 8000 h (450 V: 5000 h)	$U_R = 160\text{ V}$; $\Delta C/C: \pm 15\%$ $U_R = 250\text{ V to } 450\text{ V}$; $\Delta C/C: \pm 10\%$ $\tan \delta \leq 1.3 \times \text{spec. limit}$ $Z \leq 2 \times \text{spec. limit}$ $I_{L5} \leq \text{spec. limit}$
Useful life	CECC 30301 subclause 1.8.1	$T_{amb} = 85\text{ }^{\circ}\text{C}$; U_R and I_R applied; case $\varnothing D \times L$: 6.5 mm x 18mm to 10 mm x 25 mm: 5000 h; 10 x 30 to 21 x 38 mm: 15 000 h (450 V: 10 000 h)	$U_R = 160\text{ V}$; $\Delta C/C: \pm 45\%$ $U_R = 250\text{ V to } 450\text{ V}$; $\Delta C/C: \pm 30\%$ $\tan \delta \leq 3 \times \text{spec. limit}$ $Z \leq 3 \times \text{spec. limit}$ $I_{L5} \leq \text{spec. limit}$ no short or open circuit total failure percentage: $\leq 3\%$
Shelf life (storage at high temperature)	IEC 60384-4/ EN130300 subclause 4.17	$T_{amb} = 85\text{ }^{\circ}\text{C}$; no voltage applied; 500 h after test: U_R to be applied for 30 min, 24 h to 48 h before measurement	$\Delta C/C$, $\tan \delta$, Z : for requirements see 'Endurance test' above $I_{L5} \leq 2 \times \text{spec. limit}$



Disclaimer

ALL PRODUCT, PRODUCT SPECIFICATIONS AND DATA ARE SUBJECT TO CHANGE WITHOUT NOTICE TO IMPROVE RELIABILITY, FUNCTION OR DESIGN OR OTHERWISE.

Vishay Intertechnology, Inc., its affiliates, agents, and employees, and all persons acting on its or their behalf (collectively, "Vishay"), disclaim any and all liability for any errors, inaccuracies or incompleteness contained in any datasheet or in any other disclosure relating to any product.

Vishay makes no warranty, representation or guarantee regarding the suitability of the products for any particular purpose or the continuing production of any product. To the maximum extent permitted by applicable law, Vishay disclaims (i) any and all liability arising out of the application or use of any product, (ii) any and all liability, including without limitation special, consequential or incidental damages, and (iii) any and all implied warranties, including warranties of fitness for particular purpose, non-infringement and merchantability.

Statements regarding the suitability of products for certain types of applications are based on Vishay's knowledge of typical requirements that are often placed on Vishay products in generic applications. Such statements are not binding statements about the suitability of products for a particular application. It is the customer's responsibility to validate that a particular product with the properties described in the product specification is suitable for use in a particular application. Parameters provided in datasheets and/or specifications may vary in different applications and performance may vary over time. All operating parameters, including typical parameters, must be validated for each customer application by the customer's technical experts. Product specifications do not expand or otherwise modify Vishay's terms and conditions of purchase, including but not limited to the warranty expressed therein.

Except as expressly indicated in writing, Vishay products are not designed for use in medical, life-saving, or life-sustaining applications or for any other application in which the failure of the Vishay product could result in personal injury or death. Customers using or selling Vishay products not expressly indicated for use in such applications do so at their own risk and agree to fully indemnify and hold Vishay and its distributors harmless from and against any and all claims, liabilities, expenses and damages arising or resulting in connection with such use or sale, including attorneys fees, even if such claim alleges that Vishay or its distributor was negligent regarding the design or manufacture of the part. Please contact authorized Vishay personnel to obtain written terms and conditions regarding products designed for such applications.

No license, express or implied, by estoppel or otherwise, to any intellectual property rights is granted by this document or by any conduct of Vishay. Product names and markings noted herein may be trademarks of their respective owners.