

THE INFORMATION CONTAINED IN THIS DOCUMENT IS PROPRIETARY TO Y-S ELECTRONIC. ANY REPRODUCTION IN PART OR WHOLE WITHOUT PRIOR WRITTEN APPROVAL OR AUTHORIZATION OF Y-S ELECTRONIC IS STRICTLY PROHIBITED.

ROHS COMPLIANT

REVISONS		APPROVED BY	DATE
REV	ECN NO.	DESCRIPTION	
A		ELTON MENG	2006-05-08

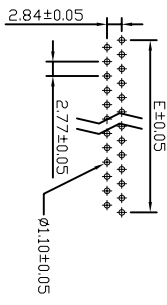
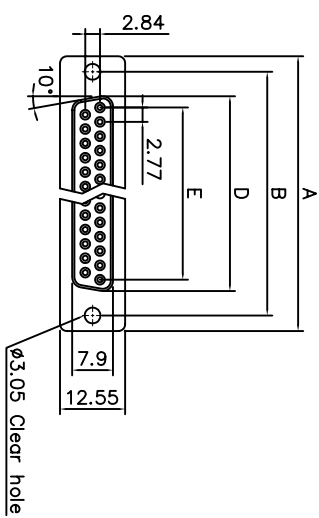

RECOMMENDED PCB LAYOUT

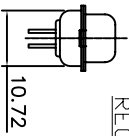
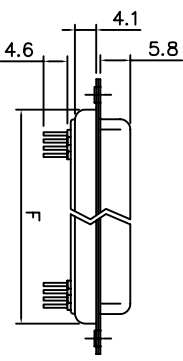

DIMENSION TABLE

POSITIONS	A±0.15	B±0.10	D±0.13	E±0.08	F±0.10
9	30.81	24.99	16.33	11.08	19.20
15	39.14	33.32	24.66	19.39	27.70
25	53.04	47.04	38.38	33.24	41.10
37	69.32	63.50	54.84	49.86	57.30

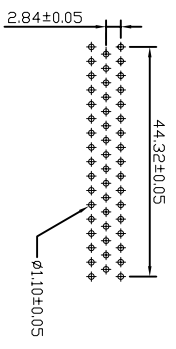

RECOMMENDED PCB LAYOUT

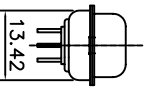
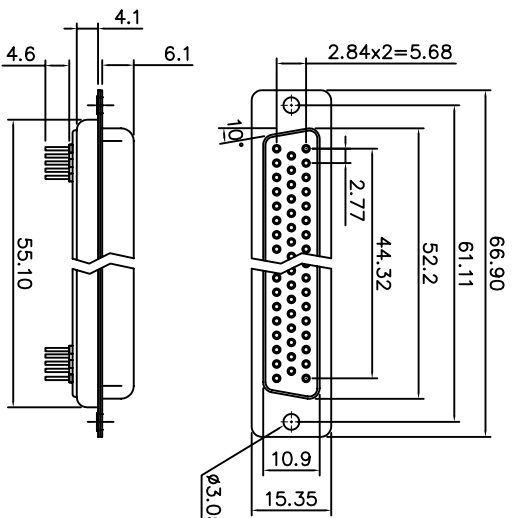

50 POSITIONS

DIMENSIONS: <input type="checkbox"/> MM [INCH] <input type="checkbox"/> INCH [mm] <input checked="" type="checkbox"/> MM ONLY		CAD GENERATED DRAWING, DO NOT MANUALLY UPDATE DRAWN BY AND DATE: JUSTIN XING 04-29-02 CHECKED BY AND DATE: JUSTIN XING 04-29-02 APPROVED BY AND DATE: KING CHIU 04-29-02 THIRD ANGLE PROJECTION		TITLE: 101 SERIES D-SUB DIP STRAIGHT TYPE DRAWING NO.: 101-XX2X2X0010	
UNLESS OTHERWISE SPECIFIED, GENERAL TOLERANCE: DECIMALS 10(015) X ±0.38 10(010) X ±0.25 10(005) .XX ±0.13 10(005)		ANGLES X° ±3° X° ±1.0°		FINISH:	
MATERIAL:		SCALE: 1:1		SIZE: A3	
Y-S ELECTRONIC CO., LTD. No. 101, Sec. 1, Long-An Street, Lu-Chu, Taoyuan, Taiwan, R.O.C. TEL: +886-3-3609819 FAX: +886-3-3609817		SHEET 1 OF 1		REV A	