

Kondensatoren für erhöhte Anforderungen

Capacitors for stringent requirements

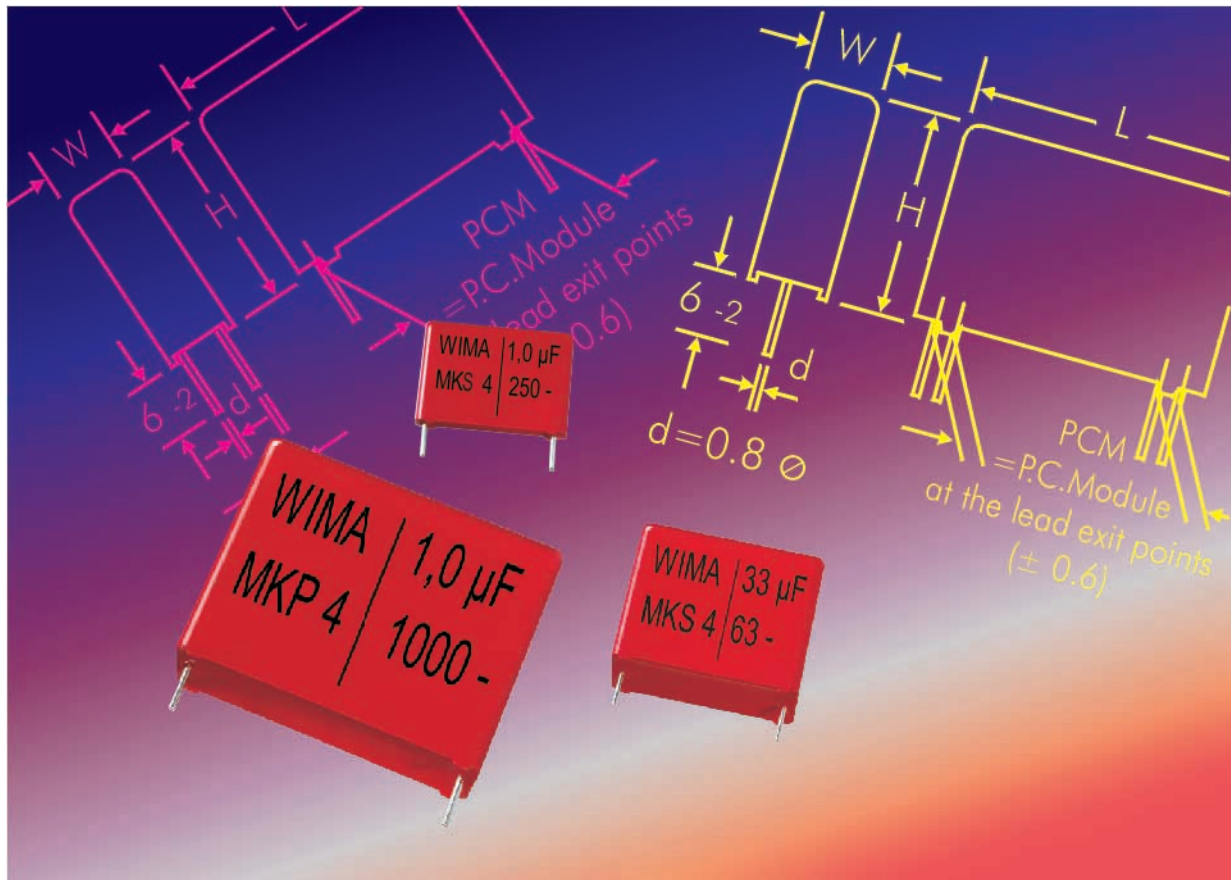

WIMA Kondensatoren für erhöhte Anforderungen umfassen ein breites Kapazitäts- und Spannungsspektrum und stehen als Polyester- oder Polypropylenausführungen in metallisierter oder Film/Folien-Bauweise zur Verfügung.

Bei metallisierten Kondensatoren (Aufbau siehe Seite 44) wird eine dünne Metallschicht als Elektrode auf eine Kunststoffolie aufgedampft. Somit können Kondensatoren mit einem sehr günstigen Kapazitäts/Volumen-Verhältnis hergestellt werden. Den höchsten C-Wert erreicht der WIMA MKS 4 mit 33 µF/63 V. Eine weitere spezifische Eigenschaft metallisierter Kondensatoren ist die hervorragende Selbstheilfähigkeit. Im Bereich eines elektrischen Durchschlages verdampft die Metallschicht und die betroffene Stelle wird isoliert. Dadurch bleibt der Kondensator voll funktionsfähig.

Beim Film/Folien-Aufbau wird die Elektrode nicht aufgedampft sondern als Metallfolie zusammen mit dem Dielektrikum gewickelt. Die so gefertigten Bauelemente besitzen aufgrund des niedrigeren Serienwiderstandes eine hervorragende Impuls- bzw. Strombelastbarkeit sowie einen sehr hohen Isolationswiderstand.

WIMA Kondensatoren für erhöhte Anforderungen stehen im Wertebereich von 100 pF bis 33 µF mit Spannungsreihen bis 2000 V- zur Verfügung. Auf Kundenwunsch können größere Bauformen als Sonderanfertigung in Vierdraht-Ausführung oder mit Anschlußlaschen gefertigt werden.

WIMA capacitors for demanding requirements cover a wide range of capacitances and voltages and are available with polyester or polypropylene dielectric as metallized or film/foil types of construction.

For metallized capacitors (construction see page 44) a thin metal coating serving as electrode is applied to the plastic film. This method makes it possible to produce capacitors with a very favourable capacitance/volume ratio. The WIMA MKS 4, with 33 µF/63 VDC, offers the highest C-rating in the WIMA range. A further specific characteristic of metallized capacitors is the excellent self-healing ability. In the case of an electric breakdown the applied metal layer evaporates. The affected area is isolated and the capacitor continues to function properly.

In the case of film/foil types, the electrode is not applied as for the metallized capacitors, but is wound with the dielectric as a metal foil. Due to their lower series resistance, the components produced this way have excellent pulse and current carrying capacities, as well as a very high insulation resistance.

WIMA capacitors for stringent requirements are available with values ranging from 100 pF through 33 µF with voltage ratings up to 2000 VDC. In accordance with customer requirements, larger box sizes can be supplied as 4-lead versions. Types with terminating tabs can also be manufactured on request.

WIMA MKS 4

Metallisierte Polyester Kondensatoren für erhöhte Anforderungen

- Für alle Standardanwendungen in Rastermaßen $\geq 7,5$ mm. ■ Großes Kapazitätsspektrum bis 33 μF und Spannungsreihen bis 2000 V-. ■ Niedriger ESR. ■ Speicherkondensator ohne Lebensdauerbegrenzung selbst bei hohen Temperaturen. ■ Gegurtet lieferbar bis einschl. Bauform 15 x 26 x 31,5/RM 27,5.

Technische Angaben

Dielektrikum: Polyäthylenterephthalat-Folie.

Beläge: Aluminium, aufmetallisiert.

Umhüllung: Flammhemmendes Kunststoffgehäuse, UL 94 V-0, Epoxidharzverguß. Farbe: Rot. Aufdruck: Schwarz.

Temperaturbereich: -55°C bis $+100^\circ\text{C}$.

Prüfungen: Nach IEC 60384-2 bzw. EN 130400.

Prüfklasse: 55/100/56 nach IEC.

Isolationswerte bei $+20^\circ\text{C}$:

U_N	$U_{\text{meß}}$	$C \leq 0,33 \mu\text{F}$	$0,33 \mu\text{F} < C \leq 33 \mu\text{F}$
50 V-	10 V	-	$\geq 1500 \text{ s (M}\Omega \cdot \mu\text{F)}$ Mittelwert: 4500 s
63 V-	50 V	$\geq 1 \cdot 10^4 \text{ M}\Omega$ Mittelwert: $5 \cdot 10^4 \text{ M}\Omega$	$\geq 3000 \text{ s (M}\Omega \cdot \mu\text{F)}$ Mittelwert: 6000 s
100 V-	100 V	$\geq 1,5 \cdot 10^4 \text{ M}\Omega$ Mittelwert: $5 \cdot 10^4 \text{ M}\Omega$	$\geq 5000 \text{ s (M}\Omega \cdot \mu\text{F)}$ Mittelwert: 15000 s
$\geq 250 \text{ V-}$	100 V	$\geq 3 \cdot 10^4 \text{ M}\Omega$ Mittelwert: $1 \cdot 10^5 \text{ M}\Omega$	$\geq 10000 \text{ s (M}\Omega \cdot \mu\text{F)}$ Mittelwert: 40000 s

Nach IEC 60384-2 Grade 1 und EN 130400.

Meßzeit: 1 min.

Kapazitätstoleranzen: $\pm 20\%$, $\pm 10\%$, $\pm 5\%$.

Verlustfaktoren bei $+20^\circ\text{C}$: $\tan \delta$

Gemessen bei	$C \leq 0,1 \mu\text{F}$	$0,1 \mu\text{F} < C \leq 1,0 \mu\text{F}$	$C > 1,0 \mu\text{F}$
1 kHz	$\leq 8 \cdot 10^{-3}$	$\leq 8 \cdot 10^{-3}$	$\leq 10 \cdot 10^{-3}$
10 kHz	$\leq 15 \cdot 10^{-3}$	$\leq 15 \cdot 10^{-3}$	-
100 kHz	$\leq 30 \cdot 10^{-3}$	-	-

Prüfspannung: $1,6 U_N$, 2 s.

Schwingen: 6 h bei 10...2000 Hz und 0,75 mm Auslenkung bzw. 10 g nach IEC 60068-2-6.

Unterdruck: 1 kPa = 10 mbar nach IEC 60068-2-13.

Stoßtest: 4000 Stöße mit 390 m/s^2 nach IEC 60068-2-29.

Spannungsderating: Die zulässige Spannung vermindert sich gegenüber der Nennspannung bei Gleichspannungsbetrieb ab $+85^\circ\text{C}$, bei Wechselspannungsbetrieb ab $+75^\circ\text{C}$ um 1,25% je 1 K.

Kurven siehe Seite 6.

Impulsbelastung bei vollem Spannungshub:

C-Wert / Capacitance $\mu\text{F}/\mu\text{F}$	Flankensteilheit V/ μs max. Betrieb/Prüfung					Pulse rise time V/ μsec max. operation/test				
	50 VDC	63 VDC	100 VDC	250 VDC	400 VDC	630 VDC	1000 VDC	1500 VDC	2000 VDC	
1000 ... 6800	-	-	-	60/600	60/600	60/600	70/700	90/900	100/1000	
0.01 ... 0.022	-	-	30/300	35/350	38/380	40/400	50/500	50/500	60/600	
0.033 ... 0.068	-	15/150	15/150	20/200	25/250	32/320	26/260	35/350	40/400	
0.1 ... 0.22	-	10/100	12/120	15/150	15/150	17/170	20/200	35/350	40/400	
0.33 ... 0.68	-	9/90	9/90	10/100	10/100	13/130	20/200	25/250	-	
1.0 ... 2.2	6/60	6/60	5/50	6/60	9/90	13/130	15/150	-	-	
3.3 ... 6.8	-	3/30	3/30	6/60	7/70	9/90	-	-	-	
10 ... 33	-	2,5/25	2,5/25	5/50	-	-	-	-	-	

Metallized polyester capacitors for stringent requirements

- For all standard applications in PCM ≥ 7.5 mm. ■ Wide capacitance range up to 33 μF and voltage ranges up to 2000 VDC. ■ Low ESR. ■ Reservoir capacitor with unlimited life expectancy even at high temperatures. ■ Available taped and reeled up to and including case size 15 x 26 x 31.5/PCM 27.5.

Technical Data

Dielectric: Polyethylene-terephthalate film.

Capacitor electrodes: Vacuum-deposited aluminium.

Encapsulation: Flame retardent plastic case, UL 94 V-0, with epoxy resin seal. Colour: Red. Marking: Black.

Temperature range: -55°C to $+100^\circ\text{C}$.

Test specification: In accord. with IEC 60384-2 and EN 130400.

Test category: 55/100/56 in accordance with IEC.

Insulation resistance at $+20^\circ\text{C}$:

U_r	U_{test}	$C \leq 0.33 \mu\text{F}$	$0.33 \mu\text{F} < C \leq 33 \mu\text{F}$
50 VDC	10 V	-	$\geq 1500 \text{ sec (M}\Omega \cdot \mu\text{F)}$ Mean value: 4500 sec
63 VDC	50 V	$\geq 1 \times 10^4 \text{ M}\Omega$ Mean value: $5 \times 10^4 \text{ M}\Omega$	$\geq 3000 \text{ sec (M}\Omega \cdot \mu\text{F)}$ Mean value: 6000 sec
100 VDC	100 V	$\geq 1.5 \times 10^4 \text{ M}\Omega$ Mean value: $5 \times 10^4 \text{ M}\Omega$	$\geq 5000 \text{ sec (M}\Omega \cdot \mu\text{F)}$ Mean value: 15000 sec
$\geq 250 \text{ VDC}$	100 V	$\geq 3 \times 10^4 \text{ M}\Omega$ Mean value: $1 \times 10^5 \text{ M}\Omega$	$\geq 10000 \text{ sec (M}\Omega \cdot \mu\text{F)}$ Mean value: 40000 sec

In accordance with IEC 60384-2 grade 1 and EN 130400.

Measuring time: 1 min.

Capacitance tolerances: $\pm 20\%$, $\pm 10\%$, $\pm 5\%$.

Dissipation factors at $+20^\circ\text{C}$: $\tan \delta$

at f	$C \leq 0.1 \mu\text{F}$	$0.1 \mu\text{F} < C \leq 1.0 \mu\text{F}$	$C > 1.0 \mu\text{F}$
1 kHz	$\leq 8 \times 10^{-3}$	$\leq 8 \times 10^{-3}$	$\leq 10 \times 10^{-3}$
10 kHz	$\leq 15 \times 10^{-3}$	$\leq 15 \times 10^{-3}$	-
100 kHz	$\leq 30 \times 10^{-3}$	-	-

Test voltage: $1.6 U_r$, 2 sec.

Vibration: 6 hours at 10...2000 Hz and 0.75 mm displacement amplitude or 10 g in accordance with IEC 60068-2-6.

Low air density: 1 kPa = 10 mbar in accord. with IEC 60068-2-13.

Bump test: 4000 bumps at 390 m/sec^2 in accord. with IEC 60068-2-29.

Voltage derating: A voltage derating factor of 1.25% per K must be applied from $+85^\circ\text{C}$ for DC voltages and from $+75^\circ\text{C}$ for AC voltages.

Graphs see page 6.

Maximum pulse rise time for pulses equal to the rated voltage:

WIMA MKS 4

Werteübersicht / General Data

Kapazität Capacitance	630 VDC/300 VAC *				1000 VDC/400 VAC *				1500 VDC/400 VAC *				2000 VDC/400 VAC *			
	W	H	L	PCM**	W	H	L	PCM**	W	H	L	PCM**	W	H	L	PCM**
1000 pF	2.5	7	10	7.5**									4	9	13	10
1500 "	2.5	7	10	7.5**									4	9	13	10
2200 "	2.5	7	10	7.5**					4	9	13	10	5	11	13	10
3300 "	2.5	7	10	7.5**					4	9	13	10	6	12.5	13	10
4700 "	2.5	7	10	7.5**	4	9	13	10	4	9.5	13	10	5	11	18	15
6800 "	3	8.5	10	7.5**	4	9	13	10	5	11	13	10	6	12.5	18	15
0.01 µF	3	8.5	10	7.5**	5	11	13	10	6	12.5	13	10	7	14	18	15
	4	9	13	10*												
0.015 "	4	9	10	7.5**	6	12.5	13	10	6	12.5	18	15	6	15	26.5	22.5
	4	9	13	10*												
0.022 "	4.5	9.5	10.3	7.5**	5	11	18	15	7	14	18	15	7	16.5	26.5	22.5
	4	9	13	10*												
0.033 "	5	10.5	10.3	7.5**	6	12.5	18	15	8	15	18	15	10.5	19	26.5	22.5
	5	11	13	10*												
0.047 "	5.7	12.5	10.3	7.5**	7	14	18	15	7	16.5	26.5	22.5	11	21	26.5	22.5
	6	12.5	13	10*												
0.068 "	5	11	18	15	8	15	18	15	8.5	18.5	26.5	22.5	11	21	31.5	27.5
0.1 µF	6	12.5	18	15	7	16.5	26.5	22.5	10.5	19	26.5	22.5	13	24	31.5	27.5
0.15 "	7	14	18	15	8.5	18.5	26.5	22.5	11	21	31.5	27.5	17	29	31.5	27.5
0.22 "	8	15	18	15	11	21	26.5	22.5	13	24	31.5	27.5	17	29	41.5	37.5
0.33 "	7	16.5	26.5	22.5	11	21	31.5	27.5	17	34.5	31.5	27.5				
0.47 "	10.5	19	26.5	22.5	15	26	31.5	27.5	20	39.5	31.5	27.5				
0.68 "	11	21	26.5	22.5	17	29	31.5	27.5								
1.0 µF	11	21	31.5	27.5	19	32	41.5	37.5								
1.5 "	15	26	31.5	27.5	20	39.5	41.5	37.5								
2.2 "	17	34.5	31.5	27.5												
3.3 "	20	39.5	41.5	37.5												

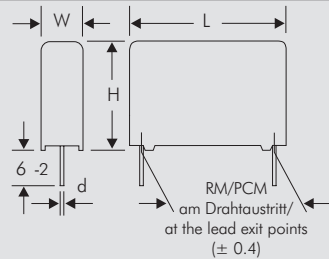

∅ d	PCM	W
0.5	7.5	≤ 3
0.7	7.5	≥ 4
0.7	10	
0.8	15 - 22.5	
0.8	27.5	≤ 15
1.0	27.5	> 15
1.0	37.5	

* Wechselspannungen: $f = 50 \text{ Hz}$; $1,4 \cdot U_{\text{eff}} \sim + U_- \leq U_N$

* AC voltage: $f = 50 \text{ Hz}$; $1,4 \times U_{\text{rms}} + \text{UDC} \leq U_r$

** PCM = Printed circuit module = Rastermaß / lead spacing.

* Bei Bestellung bitte das gewünschte Rastermaß angeben!
Wenn keine Angaben erfolgen, wird grundsätzlich das kleinere RM geliefert.

* On ordering please state the required PCM (lead spacing)!
If not specified, smaller PCM will be booked.

** Zulässige Nennwechselspannung max. 220 V~

** Admissible AC voltage 220 VAC max.

Abweichungen und Konstruktionsänderungen vorbehalten.

Rights reserved to amend design data without prior notification.

Gegurtete Ausführung siehe Seite 76. / Taped version see page 76.
Alle Maße in mm. / Dims. in mm.

Wechselspannung in Abhängigkeit von der Frequenz bei 10° C Eigenwärmung (Richtwerte).

Permissible AC voltages in relation to frequency at 10° C internal temperature rise (general data).

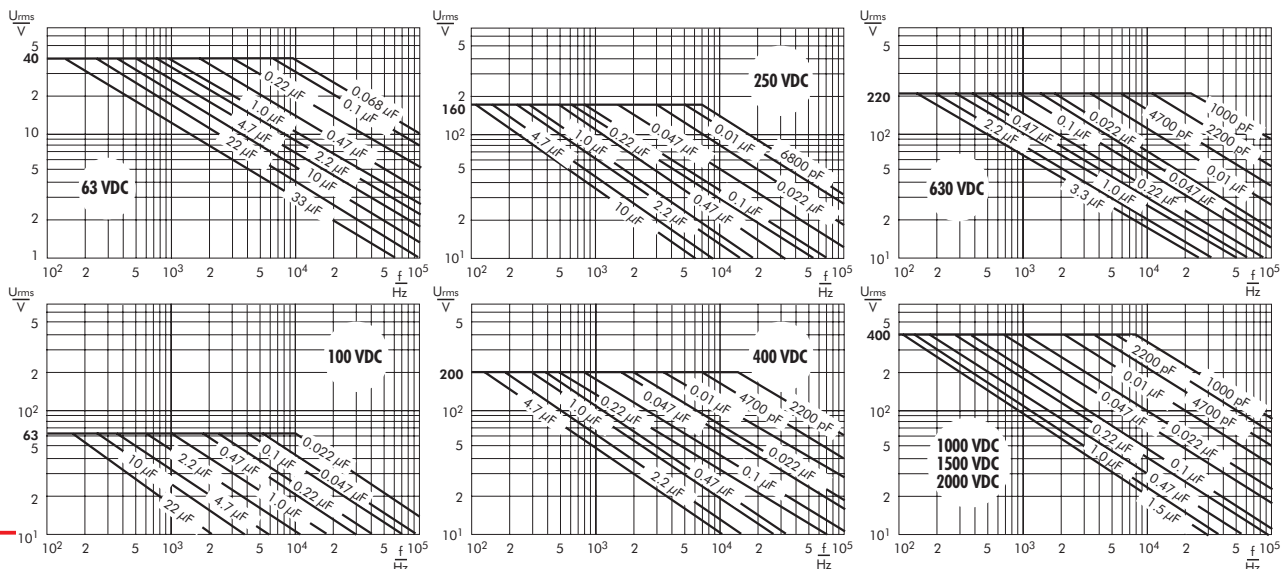

WIMA MKP 4

Metallisierte Polypropylen-Kondensatoren für erhöhte Anforderungen

■ **Niedrigster Verlustfaktor.** ■ **Konstant negativer TKc.**
 ■ **Niedrige dielektrische Absorption: geeignet für „sample-and-hold“-Schaltungen.** ■ **Für Anwendungen im Bereich hoher Frequenzen.** ■ **Hohe Kapazitätswerte z.B. für Lautsprecherweichen.** ■ **Gegurtet lieferbar bis einschl. Bauform 15 x 26 x 31,5/RM 27,5.**

Technische Angaben

Dielektrikum: Polypropylen-Folie.

Beläge: Aluminium, aufmetallisiert.

Umhüllung: Flammhemmendes Kunststoffgehäuse, UL 94 V-0, Epoxidharzverguß. Farbe: Rot. Aufdruck: Schwarz.

Temperaturbereich: -55° C bis +100° C.

Prüfungen: Nach IEC 60384-16 bzw. EN 131 200.

Prüfklasse: 55/100/56 nach IEC.

Isolationen: bei +20° C:

$C \leq 0,33 \mu\text{F}: \geq 1 \cdot 10^5 \text{ M}\Omega$ (Mittelwert: $5 \cdot 10^5 \text{ M}\Omega$).

$C > 0,33 \mu\text{F}: \geq 30\,000 \text{ s (M}\Omega \cdot \mu\text{F)}$ (Mittelwert: 100 000 s).

Nach IEC 60384-16 und EN 131 200.

Meßspannung: 100 V/1 min.

Kapazitätstoleranzen: $\pm 20\%$, $\pm 10\%$, $\pm 5\%$.

Impulsbelastung:

C-Wert pF/ μF	Flankensteilheit V/ μs max. Betrieb/Prüfung			
	250 V-	400 V-	630 V-	1000 V-
1000 ... 6800	-	55/550	60/600	65/650
0,01 ... 0,022	45/450	45/450	50/500	55/550
0,033 ... 0,068	25/250	30/300	35/350	40/400
0,1 ... 0,22	15/150	17/170	20/200	22/220
0,33 ... 0,68	10/100	13/130	15/150	18/180
1,0 ... 2,2	7,5/75	9/90	11/110	13/130
3,3 ... 4,7	6/60	8/80	9/90	-
6,8 ... 10	5/50	6/60	-	-

bei vollem Spannungshub.

Verlustfaktoren bei +20° C: $\tan \delta$

Gemessen bei	$C \leq 0,1 \mu\text{F}$	$0,1 \mu\text{F} < C \leq 1,0 \mu\text{F}$	$C > 1,0 \mu\text{F}$
1 kHz	$\leq 0,4 \cdot 10^{-3}$	$\leq 0,5 \cdot 10^{-3}$	$\leq 1,0 \cdot 10^{-3}$
10 kHz	$\leq 0,6 \cdot 10^{-3}$	$\leq 0,8 \cdot 10^{-3}$	-
100 kHz	$\leq 2,5 \cdot 10^{-3}$	-	-

Prüfspannung: $1,6 U_N, 2 \text{ s}$.

Schwingen: 6 h bei 10...2000 Hz und 0,75 mm Auslenkung bzw. 10 g nach IEC 60068-2-6.

Unterdruck: 1 kPa = 10 mbar nach IEC 60068-2-13.

Stoßtest: 4000 Stöße mit 390 m/s^2 nach IEC 60068-2-29.

Dielektrische Absorption: 0,05 %.

Spannungsderating: Die zulässige Spannung vermindert sich gegenüber der Nennspannung bei Gleichspannungsbetrieb ab +85° C, bei Wechselspannungsbetrieb ab +75° C um 1,35% je 1 K.

Kurven siehe Seite 7.

Metallized polypropylene capacitors for stringent requirements

■ **Extremely low dissipation factor.** ■ **Constantly negative TKc.** ■ **Low dielectric absorption: suitable for „sample and hold“ circuits.** ■ **Suitable for applications in high frequencies.** ■ **High capacitance values e.g. for frequency dividing in loudspeakers.** ■ **Available taped and reeled up to and incl. case size 15x26x31.5/PCM 27.5.**

Technical Data

Dielectric: Polypropylene film.

Capacitor electrodes: Vacuum-deposited aluminium.

Encapsulation: Flame retardent plastic case, UL 94 V-0, with epoxy resin seal. Colour: Red. Marking: Black.

Temperature range: -55° C to +100° C.

Test specification: In accordance with IEC 60384-16 and EN 131 200.

Test category: 55/100/56 in accordance with IEC.

Insulation resistance at +20° C:

$C \leq 0,33 \mu\text{F}: \geq 1 \times 10^5 \text{ M}\Omega$ (mean value: $5 \times 10^5 \text{ M}\Omega$).

$C > 0,33 \mu\text{F}: \geq 30\,000 \text{ sec (M}\Omega \times \mu\text{F)}$ (mean value: 100 000 sec).

In accordance with IEC 60384-16 and EN 131 200.

Measuring voltage: 100 V/1 min.

Capacitance tolerances: $\pm 20\%$, $\pm 10\%$, $\pm 5\%$.

Maximum pulse rise time:

Capacitance pF/ μF	Pulse rise time V/ μsec max. operation/test			
	250 VDC	400 VDC	630 VDC	1000 VDC
1000 ... 6800	-	55/550	60/600	65/650
0.01 ... 0.022	45/450	45/450	50/500	55/550
0.033 ... 0.068	25/250	30/300	35/350	40/400
0.1 ... 0.22	15/150	17/170	20/200	22/220
0.33 ... 0.68	10/100	13/130	15/150	18/180
1.0 ... 2.2	7.5/75	9/90	11/110	13/130
3.3 ... 4.7	6/60	8/80	9/90	-
6.8 ... 10	5/50	6/60	-	-

for pulses equal to the rated voltage.

Dissipation factors at +20° C: $\tan \delta$

at f	$C \leq 0,1 \mu\text{F}$	$0,1 \mu\text{F} < C \leq 1,0 \mu\text{F}$	$C > 1,0 \mu\text{F}$
1 kHz	$\leq 0,4 \times 10^{-3}$	$\leq 0,5 \times 10^{-3}$	$\leq 1,0 \times 10^{-3}$
10 kHz	$\leq 0,6 \times 10^{-3}$	$\leq 0,8 \times 10^{-3}$	-
100 kHz	$\leq 2,5 \times 10^{-3}$	-	-

Test voltage: $1,6 U_r, 2 \text{ sec}$.

Vibration: 6 hours at 10...2000 Hz and 0.75 mm displacement amplitude or 10 g in accordance with IEC 60068-2-6.

Low air density: 1 kPa = 10 mbar in accordance with IEC 60068-2-13.

Bump test: 4000 bumps at 390 m/sec^2 in accord. with IEC 60068-2-29.

Dielectric absorption: 0.05 %.

Voltage derating: A voltage derating factor of 1.35% per K must be applied from +85° C for DC voltages and from +75° C for AC voltages.

Graphs see page 7.

WIMA MKP 4

Werteübersicht / General Data

Kapazität Capacitance	250 VDC/160 VAC *				400 VDC/220 VAC *				630 VDC/280 VAC *				1000 VDC/400 VAC *			
	W	H	L	PCM**	W	H	L	PCM**	W	H	L	PCM**	W	H	L	PCM**
1000 pF									2.5	7	10	7.5	2.5	7	10	7.5
1500 "									2.5	7	10	7.5	2.5	7	10	7.5
2200 "									2.5	7	10	7.5	3	8.5	10	7.5
3300 "					2.5	7	10	7.5	3	8.5	10	7.5	4	9	10	7.5
4700 "					2.5	7	10	7.5	3	8.5	10	7.5	4.5	9.5	10.3	7.5*
6800 "					2.5	7	10	7.5	3	8.5	10	7.5	4	9	13	10*
					2.5	7	10	7.5	3	8.5	10	7.5*	5.7	12.5	10.3	7.5*
0.01 µF					2.5	7	10	7.5	3	8.5	10	7.5*	4	9	13	10*
0.015 "	2.5	7	10	7.5	3	8.5	10	7.5	4	9	10	7.5*	4	9	13	10*
0.022 "	2.5	7	10	7.5	4	9	10	7.5	4	9	13	10*	5	11	13	10
0.033 "	3	8.5	10	7.5	4	9	10	7.5	4.5	9.5	10.3	7.5*	4	9	13	10*
0.047 "	4	9	10	7.5*	4.5	9.5	10.3	7.5*	4	9	13	10*	5	10.5	10.3	7.5*
0.068 "	4	9	10	7.5*	4	9	13	10*	5	10.5	10.3	7.5*	4	9.5	13	10*
	4	9	10	7.5*	5.7	12.5	10.3	7.5*	5.7	12.5	10.3	7.5*	5	11	13	10*
	4	9	13	10*	5	11	13	10*	6	12.5	18	15	6	12.5	18	15
0.1 µF	4.5	9.5	10.3	7.5*	5	11	18	15	7	14	18	15	7	16.5	26.5	22.5
	4	9.5	13	10*												
0.15 "	5	10.5	10.3	7.5*	6	12.5	18	15	8	15	18	15	8.5	18.5	26.5	22.5
	5	11	13	10*												
0.22 "	5	11	18	15	7	14	18	15	7	16.5	26.5	22.5	11	21	26.5	22.5
0.33 "	6	12.5	18	15	8	15	18	15	8.5	18.5	26.5	22.5	11	21	31.5	27.5
0.47 "	7	14	18	15	7	16.5	26.5	22.5	10.5	19	26.5	22.5	13	24	31.5	27.5
0.68 "	6	15	26.5	22.5	8.5	18.5	26.5	22.5	11	21	31.5	27.5	17	29	31.5	27.5
1.0 µF	8.5	18.5	26.5	22.5	11	21	26.5	22.5	13	24	31.5	27.5	17	29	41.5	37.5
1.5 "	10.5	19	26.5	22.5	11	21	31.5	27.5	17	29	31.5	27.5	20	39.5	41.5	37.5
2.2 "	11	21	26.5	22.5	15	26	31.5	27.5	17	29	41.5	37.5	24	45.5	41.5	37.5
3.3 "	13	24	31.5	27.5	17	29	31.5	27.5	19	32	41.5	37.5				
4.7 "	15	26	31.5	27.5	19	32	41.5	37.5	20	39.5	41.5	37.5				
6.8 "	15	26	41.5	37.5	20	39.5	41.5	37.5								
10 µF	19	32	41.5	37.5												

* Wechselspannungen: $f \leq 400 \text{ Hz}$; $1,4 \cdot U_{\text{eff}} \sim + U - \leq U_N$
 AC voltage: $f \leq 400 \text{ Hz}$; $1,4 \times U_{\text{rms}} + \text{UDC} \leq U_r$

** PCM = Printed circuit module = Rastermaß.
 ** PCM = Printed circuit module = lead spacing.

* Bei Bestellung bitte das gewünschte Rastermaß angeben!
 Wenn keine Angaben erfolgen, wird grundsätzlich das kleinere RM geliefert.
 * On ordering please state the required PCM (lead spacing)!
 If not specified, smaller PCM will be booked.

Gegurtete Ausführung siehe Seite 76. / Taped version see page 76.

Alle Maße in mm. / Dims. in mm.

Abweichungen und Konstruktionsänderungen vorbehalten.
 Rights reserved to amend design data without prior notification.

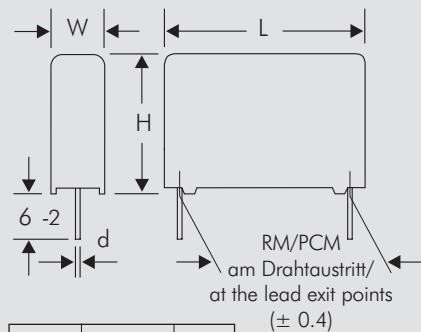

ø d	PCM	W
0.5	7.5	≤ 3
0.7	7.5	≥ 4
0.7	10	
0.8	15 - 22.5	
0.8	27.5	≤ 15
1.0	27.5	> 15
1.0	37.5	

Fortsetzung Seite 51 / Continuation page 51

WIMA MKP 4

Wechselspannung in Abhängigkeit von der Frequenz bei 10 °C Eigenerwärmung (Richtwerte).

Permissible AC voltages in relation to frequency at 10 °C internal temperature rise (general data).

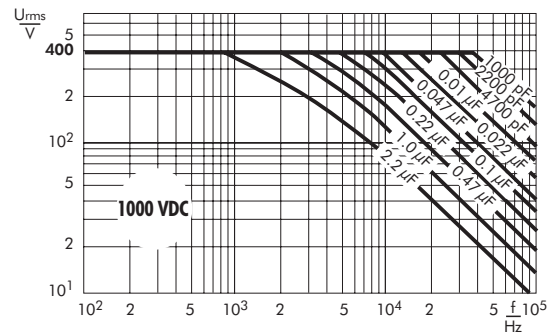
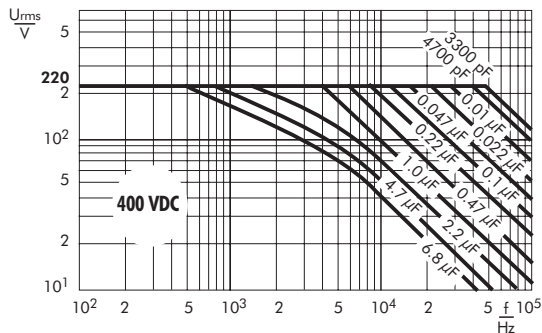
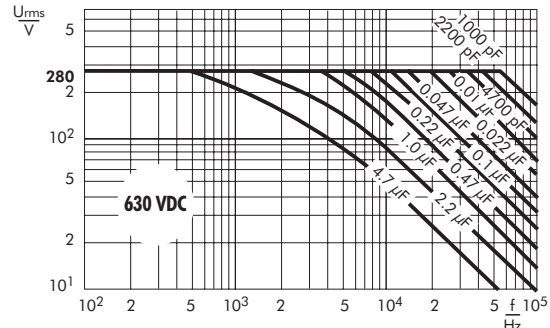
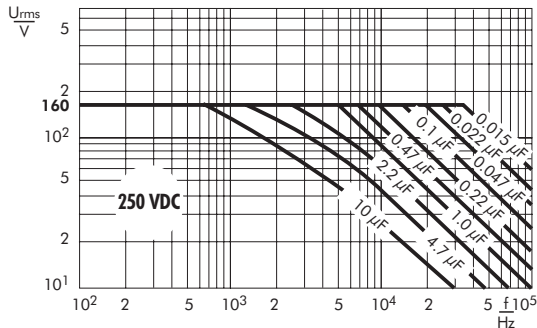

Bestellbeispiele für WIMA Kondensatoren

Example for ordering WIMA capacitors

Im Gegensatz zu anderen Herstellern benutzt WIMA keine speziellen Bestellcodes. In der Regel genügen Angaben zum Kondensatortyp, den elektrischen Werten wie Kapazität, Toleranz und Spannung sowie gegebenenfalls dem Rastermaß und der Gurtungsart.

Unlike other manufacturers WIMA does not use special part numbers. In general, the indication of the type together with the electrical values capacitance, tolerance and voltage are sufficient. PCM and taping mode may be necessary.

Nachfolgend einige Bestellbeispiele:

Please find below some examples:

Typ	RM	C-Wert	Gurtung (optional)
SMD 2220		0,1/20/100 V-	BP 330* (BP=blister pack)
MKS 2		0,1/20/ 63 V-	ROLL 18,5*
MKS 4	RM 10*	1,0/10/ 63 V-	REEL 16,5/360*
MP 3-X2	RM 15*	0,1/20/250 V~	

Family	PCM	Value	Taping (optional)
SMD 2220		0.1/20/100 VDC	BP 330* (BP=blister pack)
MKS 2		0.1/20/ 63 VDC	ROLL 18.5*
MKS 4	PCM 10*	1.0/10/ 63 VDC	REEL 16.5/360*
MP 3-X2	PCM 15*	0.1/20/250 VAC	

*vergleiche Katalogangaben

*compare catalogue data

Um also beispielsweise einen WIMA MKS 2 (wird nur im Rastermaß 5 mm gefertigt) mit dem C-Wert 0,1 µF in 63 V-, einer Toleranz von 20% und gegurtet in einer Rollenverpackung mit einer Gurthöhe von 18,5 mm zu bestellen genügen die Angaben:

For example, to order a WIMA MKS 2 (which is only available in PCM 5 mm), capacitance 0.1 µF, 63 VDC, tolerance 20%, taped in ROLL packaging, taping height 18.5 mm the following is required:

MKS 2 0,1/20/63 ROLL 18,5.

MKS 2 0.1/20/63 ROLL 18.5.

Typical dimensions for taping configuration

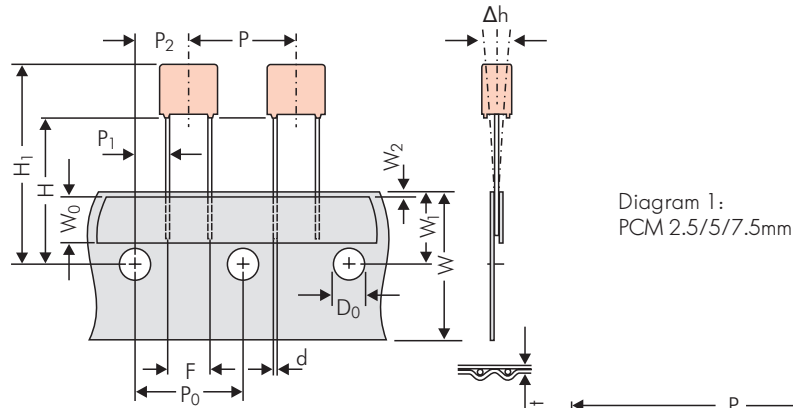

Diagram 1:
PCM 2.5/5/7.5mm

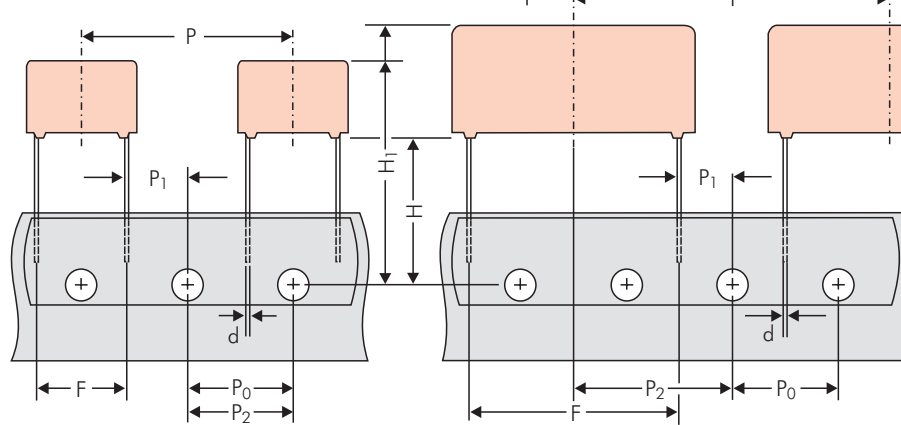

Diagram 2: PCM 10/15 mm

Diagram 3: PCM 22.5 and 27.5*mm

*PCM 27.5 taping possible with two feed holes between components

Designation	Symbol	Dimensions for radial taping							
		PCM 2.5 taping	PCM 5 taping	PCM 7.5 taping	PCM 10 taping*	PCM 15 taping*	PCM 22.5 taping	PCM 27.5 taping	
Carrier tape width	W	18.0 ±0.5	18.0 ±0.5	18.0 ±0.5	18.0 ±0.5	18.0 ±0.5	18.0 ±0.5	18.0 ±0.5	
Hold-down tape width	W ₀	6.0 for hot-sealing adhesive tape	6.0 for hot-sealing adhesive tape	12.0 for hot-sealing adhesive tape	12.0 for hot-sealing adhesive tape	12.0 for hot-sealing adhesive tape	12.0 for hot-sealing adhesive tape	12.0 for hot-sealing adhesive tape	
Hole position	W ₁	9.0 ±0.5	9.0 ±0.5	9.0 ±0.5	9.0 ±0.5	9.0 ±0.5	9.0 ±0.5	9.0 ±0.5	
Hold down tape position	W ₂	0.5 to 3.0 max.	0.5 to 3.0 max.	0.5 to 3.0 max.	0.5 to 3.0 max.	0.5 to 3.0 max.	0.5 to 3.0 max.	0.5 to 3.0 max.	
Feed hole diameter	D ₀	4.0 ±0.2	4.0 ±0.2	4.0 ±0.2	4.0 ±0.2	4.0 ±0.2	4.0 ±0.2	4.0 ±0.2	
Pitch of component	P	12.7 ±1.0	12.7 ±1.0	12.7 ±1.0	25.4 ±1.0	25.4 ±1.0	38.1 ±1.5	38.1 ±1.5 or 50.8 ±1.5	
Feed hole pitch	P ₀	12.7 ±0.3 cumulative pitch error max. 1.0 mm/20 pitch	12.7 ±0.3 cumulative pitch error max. 1.0 mm/20 pitch	12.7 ±0.3 cumulative pitch error max. 1.0 mm/20 pitch	12.7 ±0.3 cumulative pitch error max. 1.0 mm/20 pitch	12.7 ±0.3 cumulative pitch error max. 1.0 mm/20 pitch	12.7 ±0.3 cumulative pitch error max. 1.0 mm/20 pitch	12.7 ±0.3 cumulative pitch error max. 1.0 mm/20 pitch	
Feed hole centre to lead	P ₁	5.1 ±0.5	3.85 ±0.7	2.6 ±0.7	7.7 ±0.7	5.2 ±0.7	7.8 ±0.7	5.3 ±0.7	
Hole centre to component centre	P ₂	6.35 ±1.3	6.35 ±1.3	6.35 ±1.3	12.7 ±1.3	12.7 ±1.3	19.05 ±1.3	19.05 ±1.3	
Feed hole centre to bottom edge of the component	H _▲	16.5 ±0.3 18.5 ±0.5	16.5 ±0.3 18.5 ±0.5	16.5 ±0.5 18.5 ±0.5	16.5 ±0.5 18.5 ±0.5	16.5 ±0.5 18.5 ±0.5	16.5 ±0.5 18.5 ±0.5	16.5 ±0.5 18.5 ±0.5	
Feed hole centre to top edge of component	H ₁	H+H _{component} < H ₁ 32.25 max.	H+H _{component} < H ₁ 32.25 max.	H+H _{component} < H ₁ 24.5 to 31.5	H+H _{component} < H ₁ 25.0 to 31.5	H+H _{component} < H ₁ 26.0 to 37.0	H+H _{component} < H ₁ 30.0 to 43.0	H+H _{component} < H ₁ 35.0 to 45.0	
Lead spacing at upper edge of carrier tape	F	2.5 ±0.5	5.0 ^{+0.8} _{-0.2}	7.5 ±0.8	10.0 ±0.8	15 ±0.8	22.5 ±0.8	27.5 ±0.8	
Lead diameter	d	0.4 ±0.05	0.5 ±0.05	*0.5 ±0.05 or 0.7 ^{+0.07} _{-0.05}	*0.5 ±0.05 or 0.7 ^{+0.07} _{-0.05}	0.8 ^{+0.08} _{-0.05}	0.8 ^{+0.08} _{-0.05}	*0.8 ^{+0.08} _{-0.05} or 1.0 ^{+0.1} _{-0.05}	
Component alignment	Δh	± 2.0 max.	± 2.0 max.	± 3.0 max.	± 3.0 max.	± 3.0 max.	± 3.0 max.	± 3.0 max.	
Total tape thickness	t	0.7 ±0.2	0.7 ±0.2	0.7 ±0.2	0.7 ±0.2	0.7 ±0.2	0.7 ±0.2	0.7 ±0.2	
Package (see also page 14)	▲	ROLL/AMMO			AMMO				
		REEL φ 360 max. φ 30 ±1	B 52 ±2 58 ±2	} depending on comp. dimensions	REEL φ 360 max. φ 30 ±1	52 ±2 58 ±2 or 66 ±2	REEL φ 500 max. φ 25 ±1	54 ±2 60 ±2 68 ±2	} depending on PCM and component dimensions
Unit		see details page 76.							

▲ Please give „H“ dimensions and desired packaging type when ordering.

Dims in mm.

• Diameter of leads see General Data.

Please clarify customer-specific deviations with the manufacturer.

* PCM 10 and PCM 15 can be crimped to PCM 7.5.

Position of components according to PCM 7.5 (sketch 11). P₀ = 12.7 or 15.0 is possible.

Gurt-Verpackungsarten für Kondensatoren mit radialen Anschlüssen

Types of tape packaging of capacitors for automatic radial insertion

■ Rollenverpackung ROLL ROLL packaging

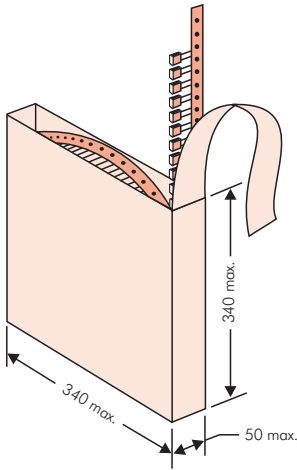

■ Lagenverpackung AMMO AMMO packaging

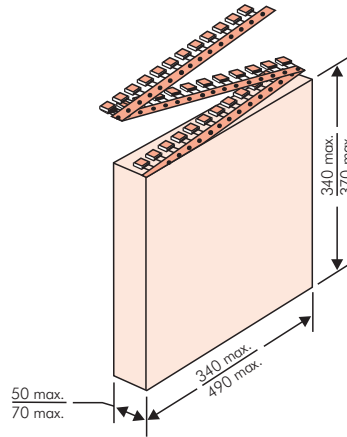

■ Trommelverpackung REEL REEL packaging

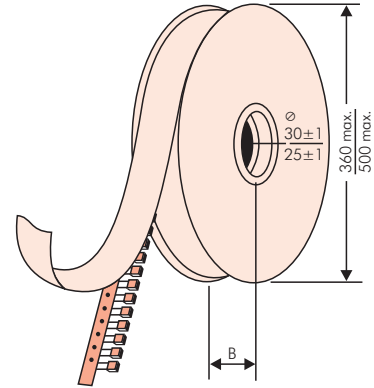

BAR CODE

Etikettierung der Verpackungseinheiten klartextlich und mit alphanumerischem Strichcode

Scanner-Decodierung von

- WIMA-Lieferernummer
- Kunden-Bestellnummer
- Kunden-Sachnummer
- WIMA-Bezeichnung
 - Artikel
 - Kapazitätswert
 - Kapazitätstoleranz
 - Nennspannung
 - Abmessungen
- WIMA-Kommissionsnummer
- Stückzahl

Zusätzlich in Klartext Lieferdatum und Kundename

BAR CODE „Code 39“

WIMA Kondensatoren		Made in Germany	
		Werk Aurich	
		26.07.00-30/31	
		Lieferer-Nr.: ...	
		Bestell-Nr.: ...	
		Sach-Nr.: ...	
MKS-4 2.2 µF 20% 100 V- 6x15x26.5 RM 10			
		WIMA Kondensatoren	
Komm-Nr.: ...		MKS-4	
		2.2 µF 20% 100 V-	
Stück: ...		6x15x26.5 RM 22.5	
Kunde: ...		26.07.00-30/31	

Labelling of package units in plain text and with alphanumerical Bar Code

Scanner decoding of

- WIMA supplier number
- Customer's P/O number
- Customer's part number
- WIMA description
 - article
 - capacitance value
 - capacitance tolerance
 - rated voltage
 - dimensions
- WIMA acknowledgement number
- Quantity

In addition date of delivery and customer's name in plain text